

TM-2440

Recorder for Ambulatory Blood
Pressure Monitor

INSTRUCTION MANUAL

Ambulatory Blood Pressure Monitor

© 2018 A&D Company, Limited. All rights reserved.

- No part of this publication may be reproduced, transmitted, transcribed, or translated into any language in any form by any means without the written permission of A&D Company, Limited.
- The contents of this manual and the specifications of the instrument covered by this manual are subject to change for improvement without notice.
- Trademarks and trade names are those of their respective owners.

Compliance

Compliance with European Directive

The device conforms to Medical Devices Directive 93/42/EEC.

This is evidenced by the CE mark of conformity accompanied by the reference number of a designated authority.

The device conforms to RoHS Directive 2011/65/EU.

Compliance with the Australian EMC Framework



The device conforms to the following requirements:

EMC Emission standard for industrial, Scientific & Medical equipment AS/ NZS 2064:1997, EMC Generic Immunity standard AS/ NZS 4252.1:1994. The above is evidenced by the C-Tick label.



Warning Definitions

To prevent accidents due to inappropriate handling, this product and its manual contain the following warning signs and marks. The meaning of these warning signs and marks are as follows.

Warning Definitions

 Danger	An imminently hazardous situation that will result in death or serious injury, if not avoided.
 Warning	A potentially hazardous situation that could result in death or serious injury, if not avoided.
 Caution	A potentially hazardous situation that may result in minor or moderate injury, if not avoided. It may also be used to alert against unsafe practice.

Symbol Examples

	The symbol \triangle indicates "Caution". The nature of the caution required is described inside or near the symbol, using text or a picture. The example indicates caution against electrical shock.
	The symbol \ominus indicates "Do not". The prohibited action is described inside or near the symbol, using text or a picture. The example indicates "Do not disassemble".
	The symbol \bullet indicates Mandatory action. The mandatory action is described inside or near the symbol, using text or a picture. The example indicates general mandatory action.

Other

Note	Provides information useful for the user to operate the device.
-------------	---

Precautions for each operation are described in the pages of this manual. Read the instruction manual before using the device.

Precautions for Use

In order to use the TM-2440 (the recorder for ambulatory blood pressure monitor) safely and correctly, carefully read the following precautions before using the monitor. The following content summarizes general matters regarding the safety of patients and operators, in addition to safe handling of the monitor. Precautions for each operation are described in the pages of this manual. Read the instruction manual before using the device.

1. Precautions When Wearing and Storing the Recorder.

Danger



Keep the recorder away from areas where flammable anesthetics or flammable gases are present, high-pressure oxygen chambers, and oxygen tents. Using the recorder in these areas may cause an explosion.

Caution





To preserve capabilities of the device, consider the following environmental conditions when using and storing the recorder. Performance of the recorder may be affected by excessive temperature, humidity and altitude.

- Avoid locations where the recorder may be splashed by water.
- Avoid locations with high temperature, high humidity, direct sunlight, dust, salt and sulfur in the air.
- Avoid locations where the recorder may be tilted, vibrated, or impacted (including during transportation).
- Avoid locations where chemicals are stored or gas occurs.
- Operation conditions :
 - Temperature : +10 °C to +40 °C,
 - Humidity : 30 %RH to 85 %RH (no condensation).

	<ul style="list-style-type: none"> ▫ Transport and storage conditions : Temperature : - 20 °C to +60 °C, Humidity : 10 %RH to 95 %RH (no condensation).
---	--

2. Precautions Before Using the Recorder.

 Caution	
	<ul style="list-style-type: none"> ▫ Confirm that the recorder operates safely and correctly. ▫ When the recorder is used in conjunction with other devices, it may cause an incorrect diagnosis or safety problems. Confirm that devices can be connected safely. ▫ Check for mutual interference with other medical devices. Confirm that the recorder can be used correctly. ▫ Use accessories, options and consumables specified by A&D. ▫ Carefully read the instruction manuals provided with optional items. Cautions and warnings are not described in this manual. ▫ For safe and correct use of the recorder, perform inspections before use. ▫ Leave the recorder one hour in normal operation condition before use and turn on it.
	<ul style="list-style-type: none"> ▫ Connect only dedicated peripheral to the USB connector. Do not connect other devices. ▫ Except for authorized cuff by A&D, do not connect to air socket.

Note

Preparation of the Recorder

- Delete last data stored in the recorder before it is used by the next patient.
- Replace batteries before the recorder is used by the next patient.

Device



- Use the recorder for diagnosis and countermeasures only.
- Confirm that the air hose and cuff are worn correctly. (Example : kink and tension of the air hose, position and direction of the cuff)

Instructions for Patient Wearing the Device

- Inform the patient how to suspend automatic blood pressure measurement to stop the recorder when alone if trouble occurs.
- Inform the patient to remove the recorder quickly when in pain or if any trouble occurs.
- Take care when using around babies and infants, as there is a danger of suffocation with air hose accidentally.

3. Precautions for Batteries Used for Blood Pressure Measurement.

Caution

- | | |
|---|--|
|  | <ul style="list-style-type: none">□ Install batteries in accordance with polarity signs "+" and "-" shown on the inside of the battery cover. (Caution for polarities)□ Replace consumed batteries to new ones at the same time.□ Remove batteries if the recorder is not to be used for a long period of time. The battery may leak and cause a malfunction.□ Use two alkaline batteries (size AA) or specified re-chargeable batteries (size AA, Ni-MH).□ Push and hold the "-" spring terminal with the battery. Slide and install the "+" terminal of the battery along the "+" terminal of the battery compartment. If the battery is installed from the "+" terminal, the battery cover may be damaged.□ Do not touch the battery and patient at the same time. It may cause an electric shock. |
|  | <p>Do not mix an old battery with a new one. Does not use batteries of different type and maker. If these use, it may cause of leakage, heat and explosion. The malfunction of the recorder may occur.</p> |

4. Precautions During Use.

Danger



Do not use the recorder while operating automobiles or other vehicles.

Example : The recorder may inhibit motion of body or arms when operating vehicle. etc.

Warning



This medical device can be only operated by doctor, authorized person by the law. Explain correct usage to the patient and ensure they can stop measurement when trouble occurs.



Do not use a mobile phone near the recorder. It may cause a malfunction.

Caution



- Stop the use of the recorder and suspend automatic blood pressure measurement if the patient feels pain in his arm or the measurement is incorrect.
- Do not use the recorder in a strong magnetic or electric field.
- Do not use the recorder on patient using a heart-lung machine.

Note

Instructions for Patient

If temperature is low, battery power becomes lower and measurement count is reduced.

5. Precautions After Using the Recorder.

Caution

Processing work of Measurement Data

- Be sure to process measurement data immediately using **dedicated peripheral**.

The Recorder

- After cleaning up accessories, arrange and store them.
- Clean up the recorder so as to be able to use next measurement.
- Suspend automatic blood pressure measurement. Otherwise, pressurization of the automatic measurement is started at next measurement start time and the cuff or other parts may be broken by the inflation.
- Remove batteries from the recorder if it is not used for a long period of time. Batteries may leak and break the recorder.
- Avoid using the recorder by a child oneself. Do not put the recorder in a place within reach of an infant. Doing so may cause accidents or damage.



Hold the connector housing when connecting and removing the cable. Do not pull the cable.

Note



Precautions After Using the Recorder (TM-2440)

Be sure to process measurement data immediately using **dedicated peripheral** after finishing measurement.

Backup Lithium Rechargeable Battery

The recorder is built with a backup lithium battery. This battery supplies power to the built-in clock when replacing AA batteries used for blood pressure measurement. The lithium battery is charged from AA batteries.

How to Extend the Life of the Backup Battery

- When first using after purchase or after storing for a month or more, replace batteries and charge the backup battery. It is enough if the backup battery is charged for 48 hours or more.
(The backup battery is always charged by AA batteries.)
- Replace with two new AA batteries when the battery indicator displays .
- When  is displayed at the battery indicator, the blood pressure measurement and data communication cannot be performed. Replace two new AA batteries.
- Remove batteries to prevent the recorder from liquid leakage of battery if the recorder is not used for a month or more.

6. The Countermeasures When the Device Has an Error

Warning



- Stop the operation and remove AA batteries. If battery terminals are shorted, battery may be hot.
- In a failure, the cuff may get hot during measurement, please handle it with care.
- Put the notice label of "**Malfunction**" "**Do not use**" on the recorder. Contact your dealer.
- Stop the recorder immediately when the measurement time is above 180 seconds and the air pressure becomes above 299 mmHg.

7. Precautions of Maintenance

Warning



- Confirm correct performance and safety of the recorder when it not used for a long period of time.
- To maintain correct measurement and safety, perform inspection and maintenance before use. The user (hospital, clinic, etc.) is responsible for management of the medical equipment. If inspection and maintenance are not performed correctly, an accident may occur.

Caution



- Use a dry lint free cloth for the care of the recorder.
Do not use volatile agents like a thinner, benzine.
Do not use wet cloth.



- Do not disassemble or modify the recorder (medical electronic device). It may cause damage.

8. Precautions and Countermeasures of Malfunction Due to Strong Electromagnetic Wave

Caution



- The recorder complies with EMC-standard IEC60601-1-2:2007. However, to prevent electromagnetic interference with other devices, do not use mobile phones near the recorder.
- If the recorder is located near strong electromagnetic waves, noise may invade in waveforms and malfunctions may occur. If unexpected malfunction occur during use, check the electromagnetic interference and take appropriate actions.

Caution

The following examples are general causes of malfunction and countermeasures.

□ Use of mobile phones

Radio waves may cause unexpected malfunctions.

- Wireless communication devices, home networking devices such as walkie-talkies mobile phones, cordless phones and these types of communication devices can affect the recorder. Therefore, they are necessary to keep a minimum distance of 33 m or more from the recorder.

□ If there is static electricity in the usage environment (discharges from devices or the surrounding area)

- Before using the recorder, ensure that the operator and patient have discharged static electricity.
- Humidify the room.

9. Environmental Protection

Caution

Before disposing of the recorder, remove the lithium battery from the recorder.

Precautions For Safe Measurement

The section describes precautions concerning the measurement and sensor. Always consult with a doctor for evaluation of the results and treatment. Self-diagnosis and self-treatment based on results can be dangerous.

Blood Pressure Measurement

Warning



Ensure the tube is not bent excessively and that air flows properly. If a bent air hose is used, air pressure may remain the cuff, which may stop blood flow to the arm.





- Do not measure the blood pressure on an arm receiving an intravenous drip for blood transfusion. This may cause an accident.
- Do not wear the cuff above an external injury. It may cause damage the wound or lead to infection.

Caution



- Confirm the condition of the patient if there is measurement trouble. It guesses that the condition worsens over the limit of measurement or the bending air hose is stopped air flow.
- Measuring blood pressure too frequently may cause bodily harm due to blood flow interference. Confirm that the operation of the device does not result in prolonged impairment of blood circulation, when using the device repeatedly.
- Blood pressure measurement may not be accurate if the patient has continuous arrhythmia, or moves excessively.

Caution

	<ul style="list-style-type: none">□ Wear the cuff at the same level as heart. (If the level is different, it occurs an error of the measurement value.)□ The recorder corresponds to artifact and shock. If there are any doubts in the measurement value, measure blood pressure by auscultation or palpation.□ Measurement error may occur if the cuff is not of suitable arm circumference for the patient.
	<p>Do not inflate the cuff before it is wrapped around the arm of the patient. It may cause of damage and explosion of the cuff.</p>

Note

- Blood pressure measurement may cause subcutaneous bleeding. This subcutaneous bleeding is temporary and disappears with time.
- If the patient uses heart-lung machine, blood pressure cannot be measured due to absence of heartbeat.
- Blood pressure cannot be measured correctly if thick cloth is worn.
- Blood pressure cannot be measured correctly if the cloth is rolled up and arm is squeezed.
- Blood pressure cannot be measured correctly if peripheral circulation is insufficient, blood pressure is excessively low or if the patient has hypothermia (blood flow is insufficient).
- Blood pressure cannot be measured correctly if the patient has frequent arrhythmia.
- Blood pressure cannot be measured correctly with unsuitable cuff size.
- Blood pressure cannot be measured correctly if the cuff is not worn at the same level as heart.
- Blood pressure cannot be measured correctly if the patient is moving or talking during measurement.
- Clinical trials have not been conducted on newborn infants and pregnant women.
- Counsel a doctor before use if you have had a mastectomy.

Cuff

Warning



- Dispose of cuffs contaminated by blood to prevent infectious disease from spreading.
- Avoid manner storing the folded cuff or twisted air hose in a tightly for extended periods of time. Such treatment may shorten the life of the components.

Measurement of Pulse Rate

Warning



Do not use the displayed pulse rate for the diagnosis of the irregular heartbeat.

Note

The recorder measures the pulse rate when measuring the blood pressure.

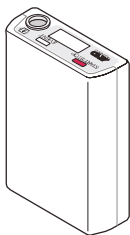

Blood pressure Recorder

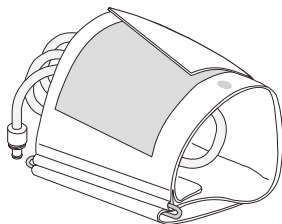

Adult cuff for left arm

Carrying holder

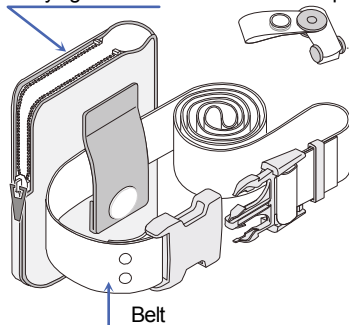

Clip

Belt

Adult cuff cover

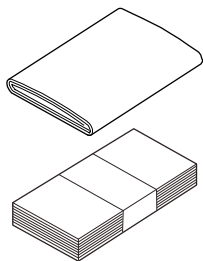

Activity record sheet (10 sheets)

Analysis software CD

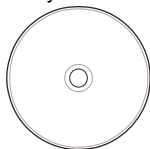

USB cable

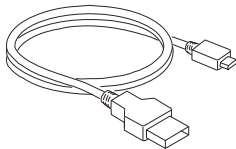

This instruction manual

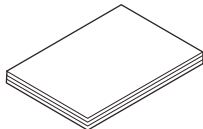

Contents

Compliance	i
Warning Definitions.....	ii
Precautions for Use	iii
Precautions For Safe Measurement	xi
Blood Pressure Measurement	xi
Cuff	xiii
Measurement of Pulse Rate.....	xiii
Packing List	xiv
1. Introduction	4
2. Features	4
3. Abbreviations & Symbols.....	6
4. Specifications.....	11
4.1. Recorder.....	11
4.2. Dimensions	14
5. Component Names.....	15
5.1. Recorder.....	15
5.2. OLED Display	16
5.3. Principal Switch Operations.....	17
5.3.1. A-BPM Operations.....	17
5.3.2. Other Operations	20

6.	Blood pressure measurement Functions	22
6.1.	Automatic Blood Pressure Measurement (A-BPM).....	22
6.1.1.	A-BPM Waiting Mode.....	23
6.1.2.	Sleep Function and Interval time	24
6.1.3.	Stopping Measurement.....	25
6.2.	Measurement Result.....	26
6.2.1.	Displaying Measurement Results.....	26
6.2.2.	Storing Measurement Results	26
6.2.3.	Outputting Measurement Results.....	27
6.2.4.	ID numbers	27
7.	Preparing the Recorder	28
7.1.	Installing Batteries (Replacing Batteries)	28
7.1.1.	How to Replace Batteries.....	30
7.2.	Preparing the Carrying Holder.....	31
7.3.	Inspection for Use	32
7.3.1.	Battery Pre-installation Checklists	32
7.3.2.	Battery Post-installation Checklists.....	33
8.	Operations	33
8.1.	Operation Flowchart	33
8.2.	Initial Settings	35
8.2.1.	Factory Settings	35
8.2.2.	The Clock and the Monitor Function of Measurement	36
8.2.3.	Initial Pressurization Value	37
8.3.	A-BPM Preset Programs	37
8.3.1.	A-BPM Items and Parameters.....	39
8.3.2.	A-BPM Program Examples	41

8.4.	Deleting Measurement Data.....	43
8.5.	Attaching the Product to the Patient.....	44
8.5.1.	Information for Patients.....	44
8.5.2.	Cuff Cover	47
8.5.3.	Attaching the Cuff, Carrying holder and Recorder	48
8.6.	Blood Pressure Measurement Operations	51
8.6.1.	A-BPM Operations.....	51
8.6.2.	Manual Measurement	53
8.6.3.	Stopping and Suspending Measurements.....	54
8.7.	Connecting the Recorder to Dedicated Peripheral.....	55
8.7.1.	Connecting with USB cable	55
9.	Maintenance	57
9.1.	Product Storage, Inspection and Safety Management.....	57
9.2.	Cleaning the Product	57
9.3.	Periodic Inspection.....	59
9.3.1.	Battery Pre-installation Inspection	59
9.3.2.	Battery Post-installation Inspection.....	60
9.4.	Disposal.....	61
9.5.	Troubleshooting	62
9.6.	Error Codes	63
10.	Optional Items (requiring order)	66
11.	Appendix	68
11.1.	Principle of Blood Pressure Measurement	68
11.2.	EMC Information	70

1. Introduction

Thank you for your Purchase!

The TM-2440 ambulatory blood pressure recorder enables to accurate measurement of patient blood pressure automatically for preset times (e.g. 24-hours continuously). This manual explains the settings, operations, modes and programs of blood pressure measurement as well as communication to **dedicated peripheral**, maintenance, specifications and warning. Read this manual for proper use and keep it in an accessible place.

2. Features

Summary

The recorder is an ambulatory blood pressure monitor equipped for portability, analytical performance and simple operation.

The recorder can measure and store blood pressure data of patients during their daily life.

Blood pressure measurement target

This recorder is designed for adults (above 12 years old).

Purpose of use

The recorder enables automatic blood pressure measurement and manual blood pressure measurement. Blood pressure readings can be used for consulting with doctors and for self managing health.

Automatic blood pressure measurement (A-BPM)

A-BPM function can specify six pairs of arbitrary start times and intervals for every 24 hours and can automatically measure and record blood pressure.

Manual blood pressure measurement

Blood pressure can be measured manually at any time, including when the A-BPM function is activated.

Portability

The weight of the recorder is approximately 120 g (excluding batteries). It is palm size and equipped a micro-pump.

Two AA alkaline batteries can be used. (LR6 or AA size)

Two rechargeable batteries (AA size, Ni-MH battery) can be used.

Operability

The settings of the recorder and the program of blood pressure measurement program can be configured easily using analysis software installed in the computer (**dedicated peripheral**).

Extensive analytical performance

Measurement interval time can be set for the automatic blood pressure measurement.

Blood pressure can be measured immediately using manual measurement anytime.

The analysis can be done effectively using analysis software installed in the computer (**dedicated peripheral**).

Shorter measurement time











The deflation speed is controlled to minimize the measurement time.









The pressurization value is controlled to minimize the measurement time.

Simple convenience

Dedicated peripheral can receive data using USB cable. Received data can be analyzed and printed easily.

3. Abbreviations & Symbols

Symbols	Meaning
SYS	S ystolic blood pressure
DIA	D iaastolic blood pressure
PUL	P ulse rate
PP	P ulse pressure PP = SYS - DIA
kPa mmHg	Unit of blood pressure
/min	Unit of pulse rate /minute
BPM	B lood pressure m easurement
A-BPM	A utomatic blood pressure measurement 24-hours blood pressure recorder.
	Displaying : A-BPM is performing.
	Battery indicator When the level 1  is displayed, replace batteries to use the recorder.
	Symbol printed in the battery compartment. Direction (polarity) to install battery.
	Memory full, Delete data to start the measurement.
	A-BPM sleep mark
	The mark is displayed during configuration.
	Symbol for small cuff Arm circumference 15 to 22 cm 5.9" to 8.7"
	Symbol for adult cuff Arm circumference 20 to 31 cm 7.8" to 12.2"
	Symbol for large cuff Arm circumference 28 to 38 cm 11.0" to 15.0"
	Symbol for extra large cuff Arm circumference 36 to 50 cm 14.2" to 19.7"

Symbols	Meaning
	Symbol printed on packing. Adult cuff is included in accessories.
	Symbol printed on packing. Batteries are excluded from accessories.
SN	Serial number
	Alert mark
Exx	Error codes. xx = 00 to 99
OLED	Organic light emitting diode
EMC	Electromagnetic compatibility
	Degree of protection against electric shocks : Equipment type BF.
	Manufacturer of the CE Marking. Date of manufacture.
	Refer to the instruction manual or booklet.
	Symbol for "Keep dry" and "Keep away from rain".
	Symbol for "Handle with care".
	The symbol of waste electrical and electronic equipment directive.

Symbols	Meaning
Sleep, Cycle, Hour, START, Operation	A-BPM symbols. #1
Not made with natural rubber latex.	Caution for patient. It is printed on the cuff.
<div style="border: 1px solid black; border-radius: 10px; padding: 5px;"> <p style="text-align: center;">⚠ Caution</p> <ul style="list-style-type: none"> • Use alkaline batteries or specified rechargeable batteries and ensure correct polarity (+, -). • Do not mix new, used or different branded batteries. • Firmly secure cuff air hose to main body. </div>	<p>⚠ Cautions on battery cover.</p> <ul style="list-style-type: none"> □ Use alkaline batteries or specified rechargeable batteries and ensure correct polarity (+, -). □ Do not mix new, used or different branded batteries. □ Firmly secure cuff air hose to main body.

#1 : Refer to "6.1. Automatic Blood Pressure Measurement (A-BPM)" and "8.3. A-BPM Preset Programs".

I.H.B.

The recorder detects an irregular heartbeat that differs $\pm 25\%$ from the average pulse rate as I.H.B. (**I**rrregular **H**eart**b**eat).

The principal factors of appearance for I.H.B. are physiological factors along with heart, disease and other factors.

Examples include body motion, an increase in body temperature, aging, physiological properties and emotional changes.

I.H.B. may be detected when a very slight vibration like trembling or shaking occurs.

Carry out analysis using a **dedicated peripheral** to know whether I.H.B. has been detected or not.

Refer to the instruction manual of analysis software for details.

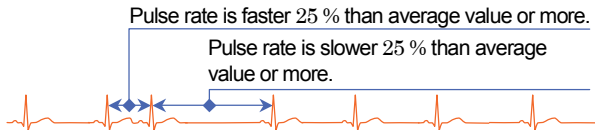

Waiting mode

A-BPM **waiting mode** is a state that blood pressure is not being measured during the **interval time**.

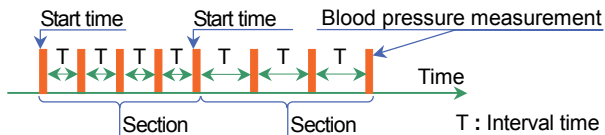



Dedicated peripheral

Dedicated peripheral means the computer principally that analysis software is installed. Analysis software is stored in accessory CD.

4. Specifications

4.1. Recorder

Items	Descriptions
Measurement method	Oscillometric measurement method
Pressure detection method	Semiconductor pressure sensor
Pressure display range	0 to 299 mmHg (299 mmHg or more is hidden)
Measurement accuracy	Pressure : ± 3 mmHg Pulse rate : ± 5 %
Minimum display division	Pressure : 1 mmHg Pulse rate : 1 beat/minute
Measurement range	Systolic pressure : 60 to 280 mmHg Diastolic pressure : 30 to 160 mmHg Pulse rate : 30 to 200 beat/minute
Depressurization	Constant exhaust with controlled leakage valve for safety mechanism
Exhaust	Electromagnetic valve
Pressurization method	Micro-pump
Automatic pressurization	85 to 299 mmHg
Interval time (of A-BPM)	Intervals at each section which divides 24 hours to six parts at the maximum. Interval : OFF, 5, 10, 15, 20, 30, 60, 120 minutes
Clock	24 hour clock
Display	OLED, 96 x 39 pixels, white characters
Measurement count	200 times or more. It varies due to measurement conditions.
Memory	Measurement data : 600 data max.

Items	Descriptions
Power supply	With the same type of batteries : <ul style="list-style-type: none"> □ 2 x 1.5V batteries (LR6 or AA size) □ Alkaline battery or Nickel–hydrogen battery (Ni–MH) 1900 mAh or more Backup battery for built–in clock : Lithium rechargeable coin cell battery ML2016
Rated voltage	DC 2.4 V and DC 3.0 V
Interface	USB : USB1.1 compliant. Cable length : 1.5 m or shorter. Micro-USB B type terminal can connect to dedicated peripheral (using standard driver software).
Operating condition	Temperature : +10 to +40 °C Humidity : 30 to 85 %RH (no condensation)
Transport and storage conditions	Temperature : –20 to +60 °C Humidity : 10 to 95 %RH (no condensation)
Atmospheric pressure both for operation and storage condition	700 to 1060 hPa
Type of protection against electric shock	Internally powered ME equipment
Type of protection against electric shock 	Type BF: The recorder, cuff and tubing are designed to provide special protection against electrical shocks.
CE Marking 	The EC directive label for medical device.
C-Tick Marking	The certification trademark registered to the ACA by the Trademark office.
Dimensions	Approx. 95 (L) × 66 (W) × 24.5 (H) mm
Mass	Approx. 120 g (excluding batteries)

Items	Descriptions
Useful life	Recorder : 5 years. Self-authentication with internal data. Proper operation and maintenance in the best conditions. Durability varies with usage conditions.
Ingress protection	Device : IP22
Default mode	Continuous measurement
Restart time after defibrillation	Immediately
EMC	IEC 60601-1-2: 2007

Note:

- # Specifications are subject to change for improvement without prior notice.
- # Clinical trial for this device is performed in based on ISO 81060-2:2013.
- # The recorder is not medical device for monitoring patient. We don't recommend the way of use that has to monitor patient in real time at place like intensive care unit.

ACA: [A](#)ustralian [C](#)ommunications [A](#)uthority

4.2. Dimensions

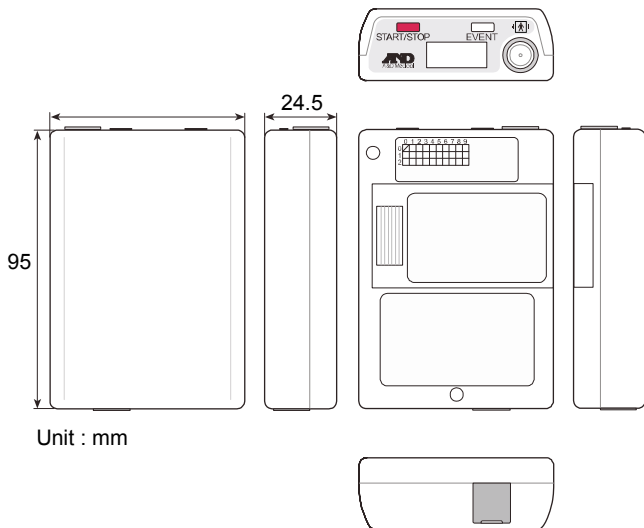

5. Component Names

5.1. Recorder

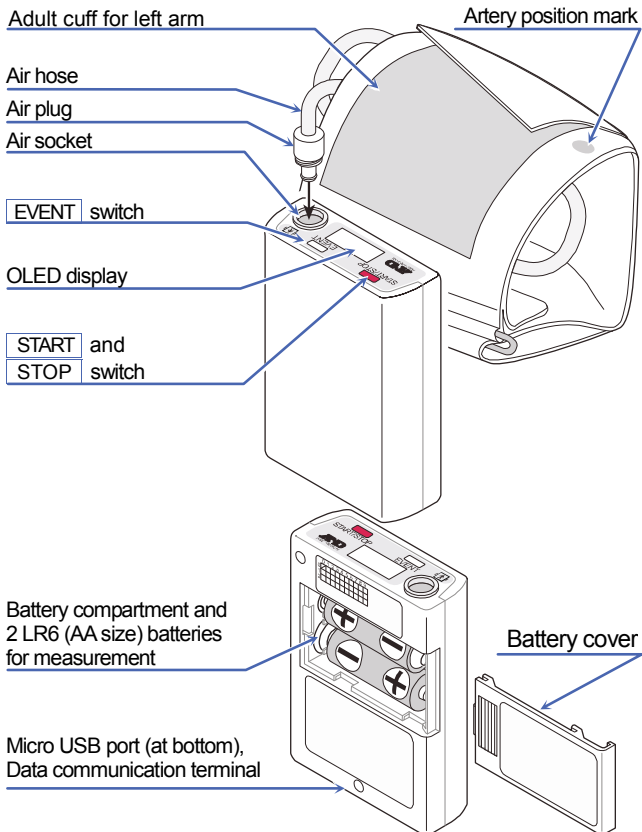

5.2. OLED Display

Note

To get accurate diagnosis, take care to accurately read the data displayed on the recorder and interpret it properly.

The state of A-BPM is indicated on the OLED display.

Clock time.

The state of settings and operation.

The measurement value of A-BPM.



SYS **S**ystolic blood pressure.
DIA **D**iaastolic blood pressure.
PUL **P**ulse rate.

mmHg Unit for blood pressure value.
/min Unit for the pulse rate.

Refer to "**3. Abbreviations & Symbols**" for the meanings of symbols on the OLED display.

Symbols	Meaning
	The mark is displayed during configuration.
	Displaying : A-BPM is performing.
	Memory full
	A-BPM sleep mark
	Battery indicator

5.3. Principal Switch Operations

5.3.1. A-BPM Operations

To start or suspend A-BPM.

Step 1. Store the preset program (of start times and intervals) for A-BPM.

Step 2. Press and hold the **EVENT** switch for 3 seconds or more to switch between the following states.

"ON"..... A-BPM is started and the \ominus mark is shown.
Blood pressure measurements are performed in accordance with preset A-BPM program.

"OFF"..... A-BPM is suspended and the \ominus mark turns off.
Manual blood pressure measurement can be performed by pressing the **START** switch, though.

To expand A-BPM interval time.

Step 1. Set the sleep mode to "ON" before the measurement.

Step 2. Start A-BPM by pressing and holding the **EVENT** switch for 3 seconds or more.

The \ominus mark is shown.

Step 3. When the **EVENT** switch is pressed during A-BPM, the interval time is doubled.

When the **EVENT** switch is pressed again, the interval time returns to basic value.

To Stop during A-BPM

When the **START/STOP** switch is pressed during the blood pressure measurement, the air is exhausted immediately and the current measurement is stopped. However, A-BPM is continued. The next blood pressure measurement is performed in accordance with A-BPM settings.

To set the program for A-BPM.

- Step 1. If the indication of the display is hidden, press the **START/STOP** or **EVENT** switch to return to the display of waiting mode.
- Step 2. If the \odot mark is shown, press and hold the **EVENT** switch for 3 seconds or more to suspend A-BPM.
- Step 3. While pressing and holding the **START/STOP** switch, press and hold the **EVENT** switch for 3 seconds or more. **Sleep** is displayed on the OLED display.
- Step 4. Operation switches are as follows:
Refer to "8.3.1. A-BPM Items and Parameters"
EVENT switchChange the current parameter.
START/STOP switchDecision, next item, end of settings.

To measure blood pressure during A-BPM immediately. (Manual blood pressure measurement of A-BPM)

- Step 1. If the indication of the OLED display is hidden, press the **START/STOP** or **EVENT** switch to return to the display of A-BPM waiting mode. A-BPM **waiting mode** is a state that blood pressure is not measured during the **interval time**.
- Step 2. Press the **START/STOP** switch during A-BPM waiting mode.

To adjust the clock.

To set the monitor function of A-BPM.

- Step 1. If the indication of the display is hidden, press the **START/STOP** or **EVENT** switch to return to the display of waiting mode.
- Step 2. If the ⌚ mark is shown, press and hold the **EVENT** switch for 3 seconds or more to suspend A-BPM.
- Step 3. While pressing and holding the **START/STOP** switch, press and hold the **EVENT** switch for 6 seconds or more. **Display** is displayed on the OLED display.
- Step 4. Operation switches are as follows:
Refer to "8.2.2. The Clock and the Monitor Function of Measurement"
EVENT switchChange the current parameter.
START/STOP switchDecision, next item, end of settings.

5.3.2. Other Operations

To return from waiting mode and show the monitor.

If the indication of the OLED display is hidden, press the **START/STOP** or **EVENT** switch to return to the display of waiting mode.

Deleting measurement data

- Step 1. If the indication of the display is hidden, press the **START/STOP** or **EVENT** switch to return to the display of waiting mode.
- Step 2. If the ⌚ mark is shown, press and hold the **EVENT** switch for 3 seconds or more to suspend A-BPM.
- Step 3. While holding the **START/STOP** switch and hold the **EVENT** switch for 9 seconds or more. **DataClear** is displayed on the OLED display.
- Step 4. Press and hold the **START/STOP** switch for 3 seconds. Data is deleted and the recorder returns to waiting mode.

To start data communication with dedicated peripheral using the USB cable.

- Step 1. Connect the micro USB cable between the recorder and **dedicated peripheral**.
- Step 2. The buzzer will sound and the following symbol appears on the OLED display.
The state of data communication enters standby mode.

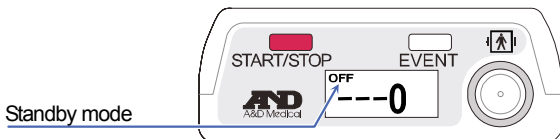

- Step 3. Carry out analysis using the **dedicated peripheral**. The state of data communication only enters active online mode during USB communication.

6. Blood pressure measurement Functions

The recorder is equipped with automatic blood pressure measurement (A-BPM) and can store measurement states and measurement results.

6.1. Automatic Blood Pressure Measurement (A-BPM)

Caution



When the A-BPM function is not used, suspend the function by pressing and holding the **EVENT** switch for 3 seconds or more so that the  mark turns off. Otherwise, the measurement will start at the next start time and the cuff may burst.

The A-BPM function measures the blood pressure at preset intervals using the built-in clock and stores the measurement result in the memory.

A-BPM can be started and suspended by pressing and holding the **EVENT** switch 3 seconds or more.

The  mark is displayed on the OLED display while A-BPM is used. Blood pressure is measured automatically at the A-BPM start time.

The initial pressurization value is set to 180 mmHg at the factory. If the first pressurization is not enough, re-pressurizations are performed automatically up to two times.

When you delete data in the memory or suspend A-BPM, the pressurization value is reset to the initial pressurization value.

When a measurement error occurs and the waiting time until the

next start time is longer than 8 minutes, blood pressure is measured once after 120 seconds. The measurement result is stored in the memory.

If you want to suspend A-BPM, press and hold the EVENT switch for 3 seconds or more.

6.1.1. A-BPM Waiting Mode

In the A-BPM waiting mode, the OLED display shows the current time together with the ⌚ mark as follows.

- # In waiting mode, the indicators are automatically hidden. Press any switch to show items.

A-BPM **waiting mode** is a state that blood pressure is not measured during the interval time.

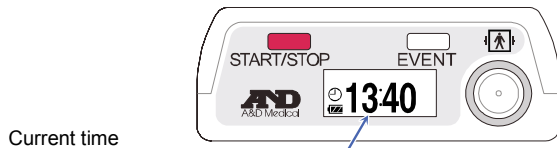

6.1.2. Sleep Function and Interval time

Set the sleep mode to "ON" in the preset program.

When the EVENT switch is pressed during A-BPM, the interval time doubles.

When the EVENT switch is pressed again in A-BPM, the interval time returns to original length.

Refer to "8.3. A-BPM Preset Programs" for information on how to set the sleep mode.

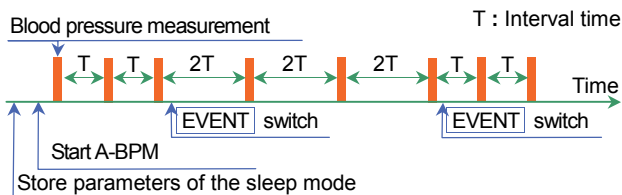

6.1.3. Stopping Measurement

When the **START/STOP** switch is pressed during the blood pressure measurement, the air is exhausted immediately and the current measurement is stopped. However, A-BPM is continued. The next blood pressure measurement is performed in accordance with A-BPM settings.

Note

When measurement is stopped, the stop code **E07** is displayed on the OLED display and is stored in the memory.

6.2. Measurement Result

6.2.1. Displaying Measurement Results

The monitor function can select "**Display ON**" or "**Display OFF**" command of the measurement result of A-BPM.

The content of "**Display ON**" command includes "Pressure value during the measurement", "measurement result" and "Error code for the measurement result".

When "**Display OFF**" command is selected, the clock is displayed.

The factory settings is set to "**Display ON**".

Refer to "**8.2.2 The Clock and the Monitor Function of Measurement**".

6.2.2. Storing Measurement Results

Caution



Data processing of the measurement result

Do not use in a strong electromagnetic field.

The memory capacity for the measurement result is 600 data set.

When the memory is filled, the  mark is displayed and the recorder cannot perform measurement until data is deleted from the memory.

Note

Delete data in the memory before giving the recorder to a new patient. We recommend to use the memory data of the recorder for each person separately. If the recorder memorizes data of multiple people, data may be difficult to process correctly.

6.2.3. Outputting Measurement Results

The measurement data stored in the memory can be output to the peripheral using USB data transfer.

Refer to "**8.7 Connecting the Recorder to Dedicated Peripheral**".

Note

When the battery indicator displays , data transfer cannot be used. Replace batteries to use data transfer.

6.2.4. ID numbers

The factory default ID number is "1".

Configure ID numbers using **dedicated peripheral**.



Note

ID numbers cannot be configured with the recorder and require use of **dedicated peripheral**.



7. Preparing the Recorder

7.1. Installing Batteries (Replacing Batteries)

Caution

- | | |
|---|---|
|  | <ul style="list-style-type: none">□ Install two new batteries in accordance with the correct "+" and "-" direction inside the battery compartment before attaching the recorder.□ Replace both batteries at the same time.□ Remove batteries from the recorder if it is not used for a long period of time. Batteries may leak and cause a malfunction.□ Use two alkaline batteries : type LR6 or designated rechargeable AA Ni-MH batteries.□ When installing the battery in the battery compartment, first, push the spring terminal using the "-" terminal of the battery. Next, insert the "+" terminal.
If the battery is installed from the "+" terminal, the coating of the battery may be damaged by the spring terminal. |
|  | <p>Do not mix and use different kinds of batteries or used batteries and new batteries. It may cause a leak, heating or damage.</p> |

Note

- | |
|---|
| <ul style="list-style-type: none">□ When the level 1  of the battery level is displayed, replace with two new batteries before attaching the recorder.□ The recorder cannot perform blood pressure measurement or data transfer while the level 1  is displayed.□ When the battery and built-in battery are dead, nothing is displayed.□ Install batteries in accordance with the direction symbol (). |
|---|

Procedure

Step 1. Open the battery cover.

Step 2. Remove used batteries.

Step 3. Refer to the direction symbol () inside of the battery compartment. Insert two new batteries in the proper "+" and "-" direction.

Push the spring terminal using the "-" terminal of the battery.

Step 4. Insert the battery by pushing the "+" terminal.

Step 5. Insert the second battery using the same method.

Step 6. Close the battery cover.

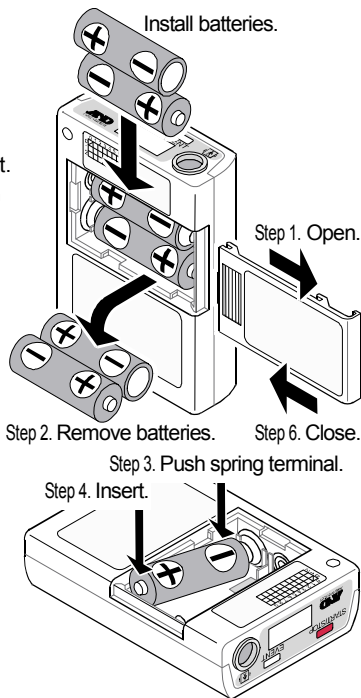

Caution



- Keep batteries and the battery cover away from infants and children with reach, to prevent accidental swallowing or other accidents.
- Use standard AA batteries. Do not use an inflated battery rechargeable battery, or one that wrapped in tape. It may become difficult to open the cover.

7.1.1. How to Replace Batteries

Measurement results and setting parameters are saved when batteries are removed. When the built-in battery runs out charge, the date is reset to 01/01/2017 00:00.

Check and adjust the current time when batteries are replaced. Refer to "**8.2.2. The Clock and the Monitor Function of Measurement**" to adjust the clock.

7.2. Preparing the Carrying Holder

Note

When the carrying holder is attached, use the accessory belt.
We recommend to use a belt to fit the recorder to the patient.

Use accessory carrying holder when the recorder is used.
To attach the carrying holder, put the carrying holder through
accessory belt or the belt of the clothes wearing.

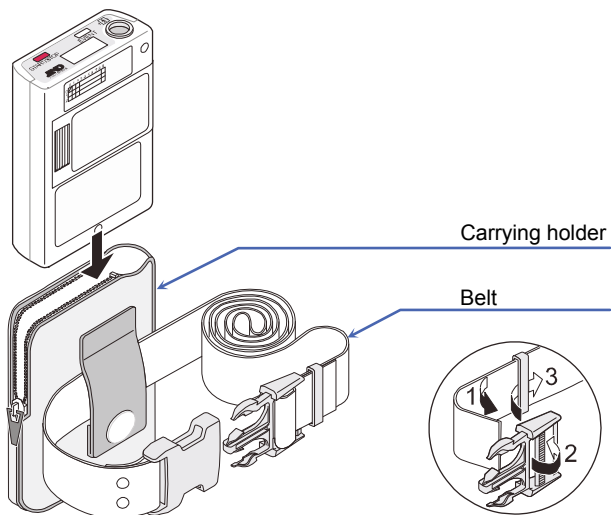

7.3. Inspection for Use

Caution



Inspect the recorder to maintain the performance, safety, effectively before use.

Confirm the following checklist before / after installing batteries. If a problem is found, stop to use the recorder and put the message of "**Malfunction**" or "**Not use**". Contact your local dealer to repair it.

7.3.1. Battery Pre-installation Checklists

No.	Item	Description
1	Exterior	No damage and deformation due to drop.
		No damage and shaky fixation to switches and etc.
2	Battery	Check batteries not to be consumed. Replace with two new batteries before the patient is used.
3	Cuff	Check that the cuff has not frayed. If the cuff is frayed, it may cause burst due to internal pressure.
4	Cuff connection	Check that there are no kinks and folding of the air hose.
		Check that the air socket and connector is connected firmly.
5	Attachments	Check that there is no damage to accessories. (Carrying holder, belt, etc)

7.3.2. Battery Post-installation Checklists

No.	Portion	Description
1	Battery	Check that there is no fire, smoke and offensive smells.
		Check that there is no strange sound.
2	Display	Check that there is no strange display.
3	Operation	Check that the recorder operates correctly.
4	Measurement	Check that the measurement operation can be performed correctly. Attachment cuff, measurement, display and result are correct.

8. Operations

8.1. Operation Flowchart

Note

The initial settings (of the built-in clock, monitor function and initial pressurization value) and preset program for A-BPM do not need to be performed every time. Perform the settings when the recorder is used for the first time, when the settings have been lost, or when the settings should be changed.

These settings can be performed using a **dedicated peripheral**, too. Refer to the instruction manual of analysis software for details.

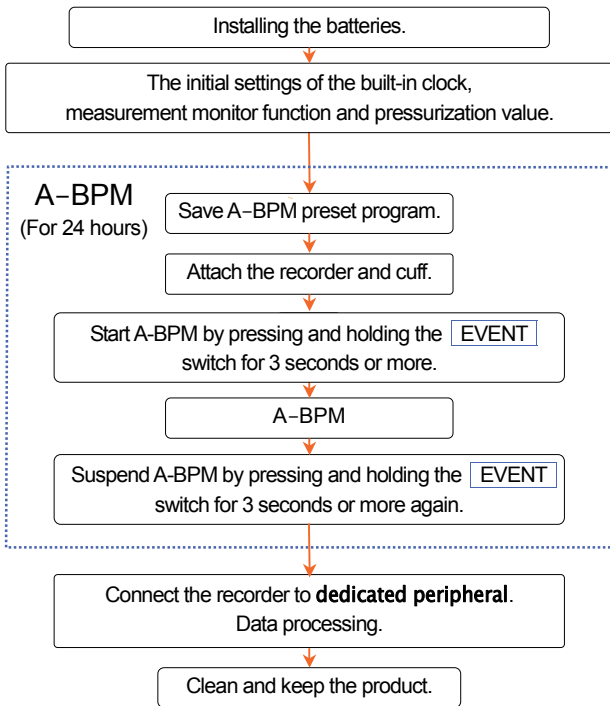

The whole procedure of use

8.2. Initial Settings

8.2.1. Factory Settings

The factory settings (initial settings) are described below :

Common items of the settings

Item	Factory setting
Monitor function	ON (is indicates them)
Year, Month, Day, Hour, Minute	Date of shipment

Items of A-BPM

Item	Factory setting
Sleep mode	OFF
Interval time when the sleep mode is ON	30 minutes
Start time of the section 1	0 hour
Interval time of the section 1	30 minutes
Start time of the section 2	0 hour #1
Start time of the automated measurement	OFF
Operation time of the automated measurement	OFF

The content of the factory settings

When the EVENT switch is pressed and held for 3 seconds or more, A-BPM is started. Blood pressure is measured every 30 minutes until A-BPM is suspended by pressing and holding the EVENT switch for 3 seconds or more again.

- #1 : The settings between the interval time of the section 2 and the interval time of the section 6 are omitted because the start time of the section 1 and 2 is the same value.

8.2.2. The Clock and the Monitor Function of Measurement

The initial settings can be configured using the following methods.

- The method to use switches on the recorder.
- The method to use **dedicated peripheral** that is connected to the recorder using the USB cable.

Procedure of operation using switches

- Step 1. If the indication of the display is hidden, press the **START/STOP** or **EVENT** switch to return to the display of waiting mode.
- Step 2. If the ⌚ mark is shown, press and hold the **EVENT** switch for 3 seconds or more to suspend A-BPM.
The ⌚ mark turns off.
- Step 3. While holding the **START/STOP** switch, press and hold the **EVENT** switch for 6 seconds or more. **Display** will display on the OLED display.
- Step 4. Operation switches are as follows:
EVENT switchChange of the current parameter.
START/STOP switchDecision, next item, end of settings.
Thereafter, use these switches in another items.
- Step 5. After configuring settings, press the **START/STOP** switch to return to waiting mode.

Item	OLED	Range
Monitor function	Display xx	xx = OFF, ON
Year	Clock Year xx	xx = 17 to 99. Last two digits of year.
Month	Clock Mon. xx	xx = 1 to 12 month
Day	Clock Day xx	xx = 1 to 31 day

Hour	Clock Hour xx	xx = 0 to 23 hour
Minute	Clock Min. xx	xx = 0 to 59 minutes

Enclosed characters : Factory settings and initial settings when batteries are consumed completely.

8.2.3. Initial Pressurization Value

The initial pressurization value is set to 180 mmHg at the factory.

8.3. A-BPM Preset Programs

The initial settings can be configured using the following methods.

- The method to use switches on the recorder.
- The method to use **dedicated peripheral** that is connected to the recorder using the USB cable.

A-BPM can use only while the automated measurement can be performed.

Procedure of operation using switches

- Step 1. If the indication of the display is hidden, press the **START/STOP** or **EVENT** switch to return to the display of waiting mode.
- Step 2. If the ⌚ mark is shown, press and hold the **EVENT** switch for 3 seconds or more to suspend A-BPM.
The ⌚ mark turns off.
- Step 3. While holding **START/STOP** switch, press and hold the **EVENT** switch for 3 seconds or more. **Sleep** will display on the OLED display.

Step 4. Specify the sleep mode using the following switches.

If sleep mode is "ON", proceed to step 5.

EVENT switchChange of the current parameter.

START/STOP switchDecision, next item.

Step 5. Specify the **start time** and **interval** up to six sections using the following switches.

EVENT switchChange of the current parameter.

START/STOP switchDecision, next item.

Step 6. Specify the **start time** and **operation time** of the automated measurement using the following switches.

EVENT switchChange of the current parameter.

START/STOP switchDecision, next item, end of the settings.

Step 7. After completing settings, the recorder returns to waiting mode.

Caution



Do not remove batteries while charging the settings.

If batteries are removed, input settings again.

8.3.1.A-BPM Items and Parameters

The preset program for A-BPM is as follows :

Item		OLED	Parameter	
Sleep mode		Sleep xx	xx = ON, OFF	#1, #2
	Interval time	Cycle xx	xx = OFF, 5, 10, 15, 20, 30 , 60, 120 minutes	
Section 1	Start time	Hour 1 xx	xx = 0 to 23 hour	
	Interval time	Cycle 1 xx	xx = OFF, 5, 10, 15, 20, 30 , 60, 120 minutes	
Section 2	Start time	Hour 2 xx	xx = 0 to 23 hour	
	Interval time	Cycle 2 xx	xx = OFF , 5, 10, 15, 20, 30, 60, 120 minutes	
Section 3	Start time	Hour 3 xx	xx = 0 to 23 hour	
	Interval time	Cycle 3 xx	xx = OFF , 5, 10, 15, 20, 30, 60, 120 minutes	
Section 4	Start time	Hour 4 xx	xx = 0 to 23 hour	
	Interval time	Cycle 4 xx	xx = OFF , 5, 10, 15, 20, 30, 60, 120 minutes	
Section 5	Start time	Hour 5 xx	xx = 0 to 23 hour	
	Interval time	Cycle 5 xx	xx = OFF , 5, 10, 15, 20, 30, 60, 120 minutes	
Section 6	Start time	Hour 6 xx	xx = 0 to 23 hour	
	Interval time	Cycle 6 xx	xx = OFF , 5, 10, 15, 20, 30, 60, 120 minutes	
	Start time	START xx	xx = OFF , 0 to 23 hour	#3, #4
	Operation time	Operation xx	xx = OFF , 1 to 27 hour	#3, #4

Automated measurement

Enclosed characters : Factory settings.

#1 : When the sleep mode is set to "ON", A-BPM is used the **Start time** and **Operation time** of the automated measurement. The **Interval time** of these sections (1 to 6) cannot use.

#2 : When sleep mode is set to "OFF", the **Interval time** is not displayed.

#3 : Example for automated measurement.

Start time : Stores a time. (0 to 23 hour)

Operation time : Set to "OFF"

Response : A-BPM starts the blood pressure measurement at the preset **Start time** and continues until A-BPM is suspended.

#4 : Example for automated measurement.

Start time : Set to "OFF"

Operation time : Stores time to be continued. (1 to 27 hours)

Response : A-BPM starts blood pressure measurement and stops after the **Operation time**.

The content of the item

Sleep mode :

The **Interval time** for the automated measurement can be specified. The **Interval time** of section 1 to 6 cannot use. Refer to "6.1.2 Sleep Function and Interval time".

Section :

24 hours can be separated to six sections in maximum. Each section can specify the **Start time** and **Interval**. A-BPM can use only while the automated measurement can be performed.

Automated measurement :

The whole of A-BPM can be controlled. Specify the **Start time** and **Operation time**. Refer to "8.3.2. A-BPM Program Examples".

8.3.2. A-BPM Program Examples

Example Start times and intervals. Simplified input.

Double sections

The **start time** of section 1 = 7:00

The **interval time** of section 1 = 15

The **start time** of section 2 = 22:00

The **interval time** of section 2 = 60

The **start time** of section 3 = 7:00 The same as section 1

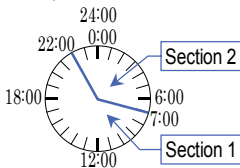

Section 3 and the following items are not displayed because the start time of section 3 is the same as section 1.

When the **start time** of section 2, 3, 4, 5 or 6 is the same as section 1, these **start times** and **intervals** are not displayed.

Example 1 Automatic measurement

The **start time** of the automated measurement = OFF,

The **operation time** of the automated measurement = OFF.

After A-BPM is started, blood pressure measurement is performed according to the **start time** and **interval** of each section until A-BPM is suspended.

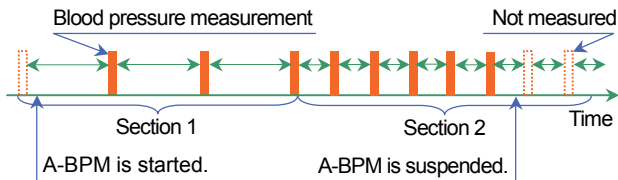

Example 2 Automatic measurement

The **start time** of the automated measurement = 7:00,

The **operation time** of the automated measurement = OFF.

After A-BPM is started, blood pressure measurement is started at 7:00. A-BPM is continued according to the **start time** and **interval** of each section until it is suspended.

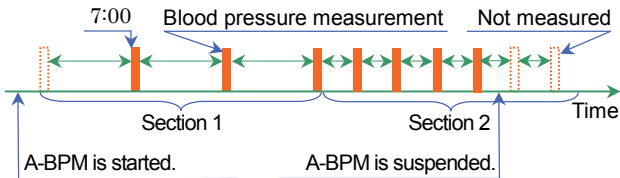

Example 3 Automatic measurement

The **start time** of the automated measurement = OFF,

The **operation time** of the automated measurement = 26 hours.

After A-BPM is started, blood pressure measurement is performed according to the **start time** and **interval** of each section for 26 hours.

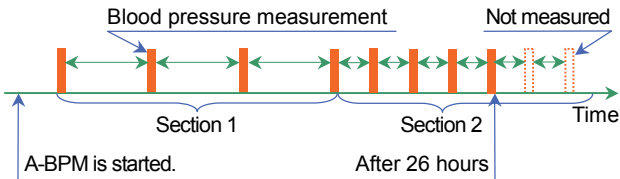

8.4. Deleting Measurement Data

Purpose of operation and explanation of function

Measurement data is deleted but settings are not deleted.

The initial settings can be configured using the following methods.



- The method to use switches on the recorder.
- The method to use **dedicated peripheral** that is connected to the recorder using the USB cable.

Caution



- If measurement data is deleted, it cannot be used again. Backup data before deletion.
- Delete measurement data of last patient before next patient uses the recorder.
- Several minutes may be needed to delete data. Keep no-operation to delete data correctly.

Procedure of operation using switches

- Step 1. If the indication of the display is hidden, press the **START/STOP** or **EVENT** switch to return to the display of waiting mode.
- Step 2. If the  mark is shown, press and hold the **EVENT** switch for 3 seconds or more to suspend A-BPM. The  mark turns off.
- Step 3. While holding the **START/STOP** switch, press and hold the **EVENT** switch for 9 seconds or more. **DataClear** will be displayed on the OLED display.
- Step 4. Press and hold the **START/STOP** switch for 3 seconds or more. Deletion of data will begin. **Erasing** will be displayed under **DataClear** on the OLED display. Several minutes may be needed to delete data.
- Step 5. After the deletion, the recorder returns to waiting mode.

8.5. Attaching the Product to the Patient

8.5.1. Information for Patients

Explain the following to the patient so that they can use the recorder safely.

Precautions during the blood pressure measurement

- Relax the arm and stay quiet when inflation begins.
- Keep the same position throughout the measurement.
- Avoid vibration and noise during the measurement.
- Blood pressure is measured for approximately 1 minute after pressurization. Be quiet until measurement finishes. The measurement process between inflating the cuff to releasing the air requires up to 170 seconds.
- The recorder may re-inflate to measure the blood pressure again after the end of pressurization. This may be caused by body motion, etc.
- The recorder may start the blood pressure measurement after approximately 120 seconds when measurement data is invalid and next measurement is after 8 minutes. This may be caused by body motion, etc.
- The recorder may obstruct vehicle and machine operation. Avoid vehicle and machine operation while wearing the recorder.

How to stop or suspend the measurement

Press the **START/STOP** switch to stop blood pressure measurement. An error code is stored in the memory. Blood pressure is measured again after 120 seconds.

Concerning of A-BPM, only the current blood pressure measurement is stopped, and measurement will be performed at the next **start time**.

To suspend A-BPM, press and hold the **EVENT** switch for 3 seconds or more so that the  mark turns off.

Remove the cuff if the current blood pressure measurement can not be stopped using the **START/STOP** switch.

Caution



- Press the **START/STOP** switch to stop blood pressure measurement. An error code is stored in the memory. During A-BPM, only the current blood pressure measurement is stopped, and measurement will be performed at the next **start time**.
- When a pain of the arm or unexpected condition occur, stop the measurement, remove the cuff and consult the doctor. Suspend A-BPM by pressing and holding the **EVENT** switch for 3 seconds or more so that the  mark turns off.

Press and hold the **EVENT** switch for 3 seconds or more again to resume A-BPM automated measurement. The  mark is shown on the OLED display. Recording of data is carried out continuously except during the suspended period.

How to use manual measurement during A-BPM

- Step 1. If the indication of the OLED display is hidden, press the **START/STOP** or **EVENT** switch to return to the display of A-BPM waiting mode.
- Step 2. Press the **START/STOP** switch to immediately measure the blood pressure during A-BPM.
- Step 3. Measurement results are stored in the memory.
- When the **START/STOP** switch is pressed during measurement, the measurement is suspended.

Precautions when wearing the recorder

- The recorder is precision instrument. Do not drop or shock the recorder.
- The recorder and cuff are not waterproof (water resistant). Prevent the product from contacting rain, sweat and water.
- Do not put anything on the product.
- When the cuff is moved by excessive motion and exercise, attach the cuff again.
- Arrange the air hose so that kinks do not form and so that it does not wrap around the neck at bedtime.

Installing batteries (replacing batteries)

When the  mark is displayed, the recorder can not measure blood pressure or communicate with **dedicated peripheral**. Replace with two new batteries immediately.

8.5.2. Cuff Cover

Note

Keep the cuff and cuff cover clean.

- Change the cuff cover for each person.
- Use the cuff cover appropriate optional cuffs.
- The cuff cover can be used to on the right arm and left arm.

8.5.3. Attaching the Cuff, Carrying holder and Recorder

Caution

- ❗
 - ❑ Do not attach the cuff if the patient has dermatitis, external wounds, etc.
 - ❑ Remove the cuff and stop use if dermatitis or other symptom appear to the patient.
 - ❑ Prevent air hose from coiling around neck and body.
 - ❑ Take care when using around infants, as there is a danger of suffocation.
 - ❑ Insert the connector of the air hose firmly until the end of rotation. If the connection is improper, it may cause air leakage and measurement error.

Note

- ❑ Attach the cuff at the right position and wrap around the arm to measure the blood pressure correctly.
- ❑ Prevent the cuff and air hose from vibrating during measurement. The recorder measures delicate change of the air pressure inside the cuff.
- ❑ The accessory cuff is an adult cuff for the left arm. If cuff size does not fit, purchase optional cuff.

	Arm circumference	
Small cuff	15 to 22 cm	5.9" to 8.7"
Adult cuff	20 to 31 cm	7.8" to 12.2"
Large cuff	28 to 38 cm	11.0" to 15.0"
Extra large cuff	36 to 50 cm	14.2" to 19.7"

- ❑ Keep the cuff clean.
- ❑ We recommend the patient use the carrying holder and belt.
- ❑ The cuff is not made with natural rubber latex.

How to put on the cuff, recorder and holder

- Step 1. Pass the end of the cuff through the ring and make the shape of bracelet.
- Step 2. Find the brachial artery of left arm using palpation.
- Step 3. Attach the cuff directly against the skin so that the white mark is directly over the brachial artery and the lower edge of the cuff is put on approximately 1 – 2 cm above the inside of the elbow.
- Step 4. Wrap the cuff so that the ring is within the range, it is flat and does not slip down, but has room to insert two fingers.
- Step 5. Fix the air hose using adhesive tape so as to pass over the shoulder.
- Step 6. Pass the belt through the carrying holder.
- Step 7. Adjust the belt so that the carrying holder is on left side.
- Step 8. Connect the air plug to the air socket on the recorder.
- Step 9. Put the recorder into the carrying holder.

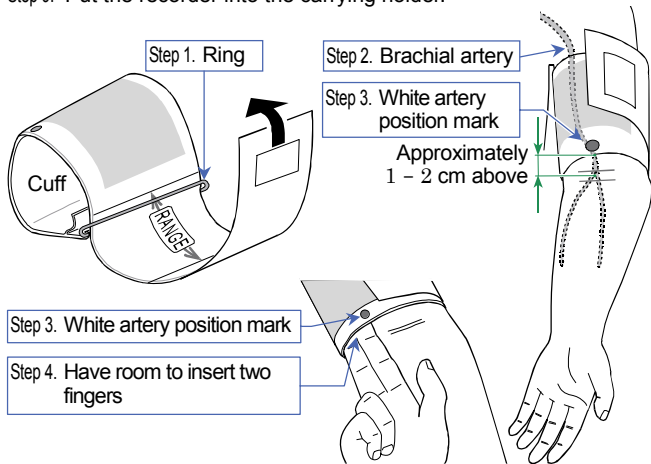

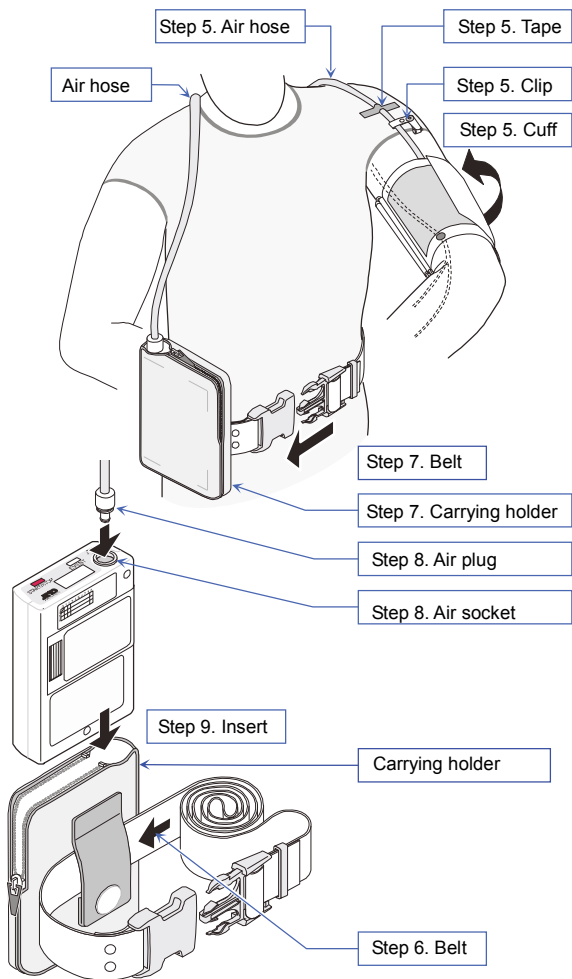

8.6. Blood Pressure Measurement Operations

8.6.1. A-BPM Operations

When A-BPM is started, blood pressure is measured in accordance with the preset parameters.

Note

- Set the built-in clock and initial pressurization value before measurement because A-BPM uses them. Refer to "8.2.2. The Clock and the Monitor Function of Measurement" and "8.3. A-BPM Preset Programs".
- When the recorder is removed, suspend A-BPM by pressing and holding the **EVENT** switch for 3 seconds or more.
If the recorder is removed during A-BPM, the inflation of the cuff is started next **start time**, the cuff may break.
To resume A-BPM, press and hold the **EVENT** switch for 3 seconds or more again.
- The  mark is displayed while A-BPM is activated.
- Manual blood pressure measurement can be performed during A-BPM waiting mode.
- The measurement result of the manual blood pressure measurement can be stored in the memory.
- When A-BPM is stopped, the error code **E07** is displayed on the OLED display and stored in the memory.

To start A-BPM

- Step 1. Press and hold the **EVENT** switch for 3 seconds or more.
- Step 2. The  mark is shown on the OLED display. A-BPM is started.

To suspend A-BPM

Step 1. Press and hold the **EVENT** switch for 3 seconds or more.

Step 2. The  mark is hidden. A-BPM is suspended.

To Stop during A-BPM

When the **START/STOP** switch is pressed during the blood pressure measurement, the air is exhausted immediately and the current measurement is stopped. However, A-BPM is continued. The next blood pressure measurement is performed in accordance with A-BPM settings.

To measure blood pressure during A-BPM immediately (Manual blood pressure measurement of A-BPM)

Step 1. If the indication of the OLED display is hidden, press the **START/STOP** or **EVENT** switch to return to the display of A-BPM waiting mode. A-BPM **waiting mode** is a state that blood pressure is not measured during the **interval time**.

Step 2. Press the **START/STOP** switch during A-BPM waiting mode.

To expand the interval time, or bring back it

When sleep mode is "ON" and the **EVENT** switch is pressed during A-BPM waiting mode, the interval time is doubled.

8.6.2. Manual Measurement

Use the manual blood pressure measurement for a tentative test measurement and immediate blood pressure measurement.

Note

- Manual blood pressure measurement can start immediately in a waiting mode.
- The measurement result is stored in the memory.

To measure blood pressure during A-BPM immediately. (Manual blood pressure measurement of A-BPM)

Step 1. If the indication of the OLED display is hidden, press the

START/STOP or **EVENT** switch to return to the display of A-BPM waiting mode. A-BPM **waiting mode** is a state that blood pressure is not measured during the **interval time**.

Step 2. Press the **START/STOP** switch during A-BPM waiting mode.

8.6.3. Stopping and Suspending Measurements

The A-BPM function can be suspended when necessary. And ongoing A-BPM or manual blood pressure measurement can be stopped immediately.

Note

When blood pressure measurement is stopped, the stop code **E07** is displayed on the OLED display and is stored in the memory.

To suspend A-BPM

Step 1. Press and hold the **EVENT** switch for 3 seconds or more.

Step 2. The  mark is hidden. A-BPM is suspended.

To stop ongoing blood pressure measurement

When the **START/STOP** switch is pressed during blood pressure measurement, the air is exhausted immediately and the current measurement is stopped.

However, during A-BPM, this function is not suspended. The next blood pressure measurement is performed in accordance with the A-BPM settings.

8.7. Connecting the Recorder to Dedicated Peripheral

8.7.1. Connecting with USB cable

Refer to the instruction manual of analysis software concerning of the communication settings.

Caution

Connection of the cable

- Connect an authorized USB cable to the micro USB terminal.
- Insert the cable in the correct direction. Improper connection may cause failure and malfunction. Confirm that the terminal cable is properly connected.
- Do not measure blood pressure while connecting a cable. Cable may become wrapped around the body or neck.

Preparation of dedicated peripheral

- Remove the recorder and cuff from the patient before connecting the recorder (TM-2440) to **dedicated peripheral**.

#1 : We recommend to use the product that is complied with the IEC60601-1-2: 2007.

#2 : Use a USB cable shorter than 1.5 m (4.9 ft).

To connect the recorder to dedicated peripheral using the USB cable

Step 1. Open the micro USB terminal on the recorder.

Connect accessory USB cable.

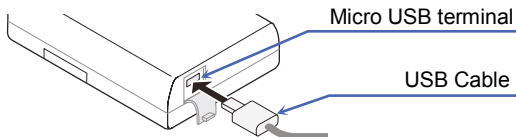

To start data communication with dedicated peripheral

Step 1. Connect the micro USB cable between the recorder and **dedicated peripheral**.

Step 2. The buzzer will sound and the following symbol appears on the OLED display.

The state of data communication enters standby mode.

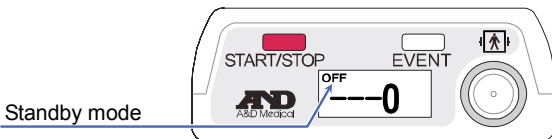

Step 3. Carry out analysis using the **dedicated peripheral**.

The state of data communication only enters active online mode during USB communication.

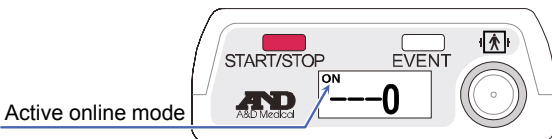

To stop data communication with dedicated peripheral

Step 1. Remove the cable in the standby mode.

9. Maintenance

9.1. Product Storage, Inspection and Safety Management

Medical instruments such as this recorder must be managed so that they function properly when necessary and to reliably maintain the safety of the patient and operator. As basic rule, it is necessary that the patient inspects this instrument with daily checks such as the "Inspection before use".

Daily management such as the inspection before use is necessary to maintain the performance, safety and effectiveness of the recorder.

We recommend to a periodic inspection the recorder every year.

Note

Medical institution must perform the maintenance management to ensure the safe use of the medical instrument.

9.2. Cleaning the Product

Caution

- ❑ When cleaning the recorder, do not splash water or submerge the device in water.
- ❑ Do not use the autoclave and gas sterilization (EOG, formaldehyde gas, ozone gas and etc) for sterilization.
- ❑ Do not use solvents such as thinner, petroleum benzene, etc. Clean the recorder in accordance with hospital rules every month.

Caution

Check after Cleaning



Confirm that the cuff bladder is correctly inserted inside the cuff cloth. If it is not correctly inserted, damage or explosion may occur during inflation.

Cleaning the recorder

Wipe the dirt and dust on the exterior of the recorder using soft dry cloth. Clean blood, medicines, etc. using a cloth moistened with mild detergent.

Cleaning the cuff

Do not squeeze the cuff and cuff cover when washing. Submerge the cuff and cuff cover in a mild detergent and wash so that the cloth avoids damage. Rinse with water.

Note

- The cuff and cuff cover are consumable goods.
- When measurement error occurs frequently and measurement cannot be performed, replace the cuff and cuff cover with new ones. Refer to "**10. Optional Items (requiring order)**" for information on ordering options.

9.3. Periodic Inspection

Perform the daily periodic inspection to use recorder correctly.

The inspection is described below :

9.3.1. Battery Pre-installation Inspection

Items	Description
Exterior	No damage or deformation from drops.
	No dirt, rust and scratches on any part.
	No cracking or rattling of the panel.
Operation	No damage for rattling of switches and buttons.
Display	No dirt or scratches on the display panel.
Measurement Cuff	Replace the cuff when a problem is found. The cuff is disposable. <ul style="list-style-type: none">□ If there is a crack or adhesive matter in the connection between the cuff and cuff bladder.□ If the air hose loses its flexibility and becomes hard.□ When the surface of the air hose becomes glossy or feels oily.□ When the air bladder has cracks.
	#1 We recommend to replace cuffs every three years, regardless of frequency of use.
	The air hose is not to be folded. If air remains in the cuff, it may cause peripheral dysfunction due to stopping the blood flow of the arm.
	The cuff bladder is correctly inserted inside the cuff cloth.
	No fraying of the cuff. The cuff doesn't ravel.
Wearing tools	No damage in the carrying holder, belt and cuff.
Connection	The air plug is connected to the air socket correctly.

9.3.2. Battery Post-installation Inspection

Item	Description
Exterior	No fire, smoke or offensive smells.
	No strange sounds.
Operation	No trouble with functioning of switches and buttons.
Measurement Cuff	Measurement values are closely in usual value.
	No strange sounds or actions during measurement.
Inspection of blood pressure value	If blood pressure values are incorrect, contact your local dealer.

9.4. Disposal

Concerning the disposal and recycle of the product, for environment protection, follow the laws of the local government.

Disposal of the cuff

The cuff worn on the patient is medical waste.

Dispose of it properly as medical waste.

Disposal of the rechargeable built-in battery

Caution



Remove and properly dispose of the lithium battery inside the recorder when the recorder is disposed.

Others

Name	Part	Material
Package	Case	Cardboard
	Cushion	Air cushion, special case
	Bag	Vinyl
Inside the recorder	Case	ABS + PC resin
	Internal parts	General parts
	Chassis	Iron
	Backup battery on the board	Lithium rechargeable coin cell battery : ML2016
	Battery	Alkaline battery : 1.5V LR6 or AA size Rechargeable battery : AA size Ni-MH batteries, 1900 mAh or more

9.5. Troubleshooting



Consult the following checklist and error code list before contacting your local dealer.

If this measures do not improve the problem or the problem occurs again, contact your local dealer.

Problem	Main cause	Treatment
No display after turning on.	Battery power has been consumed.	Replace to new batteries.
Data is lost when replacing batteries.	The backup battery does not charge. #1	Charge it for 48 hours using new batteries.
No pressurization	Cuff is not exactly connected.	Check the cuff and air hose concerning folding, kink and connection.
No communication #2	Communication cable is removed.	Confirm the cable to be connected correctly.
Battery cover cannot be opened	Non-standard size batteries were used.	Contact your local dealer.

#1 : Users (unauthorized maintenance personnel) cannot replace the backup battery (lithium battery) placed on the electronic board inside the recorder. The backup battery is charged from the batteries (LR6 or AA size) for the measurement.

#2 : **Dedicated peripheral** is required.

 Caution	
	Do not disassemble or modify the recorder. It may be damaged.

9.6. Error Codes

Measurement error codes

Code	Meaning	Cause and treatment
E03	Pressure zero error	Release the air left in the cuff.
E04	Low battery	Replace with new batteries.
E05	Failure of pressurization	<ul style="list-style-type: none">□ Inflation does not reach the target pressure.□ Confirm the cuff connection.□ If there are no problems with the cuff connection, the recorder may have malfunctioned and requires inspection.
E06	Pressure exceeds 299 mmHg	Body motion may be occurred in the pressurization. Relax and keep the silence during measurement. If the treatment is not enough, inspect the recorder.
E07	Force stop using START/STOP switch.	Press the START/STOP switch only when necessary.
E08	Blood pressure cannot be measured.	<ul style="list-style-type: none">□ The heartbeat cannot be detected due to body motion or noise from clothes.□ Relax and do not move.□ Confirm the position of the cuff.□ If this failure occurs even when relaxed, contact your dealer to inspect and repair the recorder.
E10	Excessive body motion.	Relax and keep silent during the measurement.

Code	Meaning	Cause and treatment
E20	Out of range, $30 \leq \text{PUL} \leq 200$	If these errors occur multiple times, try another blood pressure measurement. #1 PP = SYS - DIA SYS : S ystolic blood pressure DIA : D iaastolic blood pressure PP : P ulse pressure
E21	Out of range, $30 \leq \text{DIA} \leq 160$	
E22	Out of range, $60 \leq \text{SYS} \leq 280$	
E23	Out of range, $10 \leq \text{PP} \leq 150$ #1	
E30	Measurement is above 180 seconds.	If the inflation speed or exhaust speed is slow, an inspection is necessary.
E31	Exhaust is above 90 seconds.	The exhaust speed may be slow, an inspection is necessary.
E4B	Heartbeat cannot be detected.	Heartbeat cannot be detected because of body motion, etc. Measure the blood pressure while relaxed and do not moving.
E60	The settings of the interval time are incorrect.	If the interval time is set to 120 minutes, the difference between last start time and next start time cannot divide into two hours perfectly.
E90	Zero pressure error for safety circuit.	<ul style="list-style-type: none"> □ Displays at the measurement start time. □ Release the air remaining in the cuff completely.

Code	Meaning	Cause and treatment
E91	Safety circuit detects over load pressure.	<ul style="list-style-type: none"> □ Body motion may be detected at the pressurization. Relax and do not move while the measurement. □ If this error occurs even when relaxed and not moving, contact your dealer for inspection.

Hardware error codes of the recorder

Code	Meaning	Cause and treatment
E52	Memory error	<ul style="list-style-type: none"> □ Malfunction of the built-in memory. □ Contact your dealer for inspection.

Note

The error codes may be changed without any notice.

10. Optional Items (requiring order)

Cuffs

Name	Description	Order code
Small cuff for left arm	Arm circumference 15 to 22 cm 5.9" to 8.7"	TM-CF202A
Adult cuff for left arm	Arm circumference 20 to 31 cm 7.8" to 12.2"	TM-CF302A
Large cuff for left arm	Arm circumference 28 to 38 cm 11.0" to 15.0"	TM-CF402A
Extra large cuff for left arm	Arm circumference 36 to 50 cm 14.2" to 19.7"	TM-CF502A
Adult cuff for right arm	Arm circumference 20 to 31 cm 7.8" to 12.2"	TM-CF802A
Disposable cuff	10 sheets	TM-CF306A
Small cuff cover	for left arm 10 sheets	AX-133024667-S
Adult cuff cover	for left arm 10 sheets	AX-133024500-S
Large cuff cover	for left arm 10 sheets	AX-133024663-S
Extra large cuff cover	for left arm 10 sheets	AX-133024503-S
Adult cuff cover	for right arm 10 sheets	AX-133024353-S
Small cuff cloth	for left arm 2 sheets	AX-133025101-S
Adult cuff cloth	for left arm 2 sheets	AX-133024487-S
Large cuff cloth	for left arm 2 sheets	AX-133025102-S
Extra large cloth	for left arm 2 sheets	AX-133025103-S
Adult cuff cloth	for right arm 2 sheets	AX-133025104-S
Air hose adaptor	—	TM-CT200-110

Data analysis

Name	Description	Order code
USB cable	—	AX-KOUSB4C

Others

Name	Description	Order code
Activity record sheet	10 sheets	AX-PP181-S
Carrying holder	—	AX-133025995
Belt	—	AX-00U44189
Rechargeable battery	Ni-MH type, AA size, 2 pieces	AS-3UTG-2BP
Adaptor to charge battery	—	AS-NC-M58
Clips	5 pieces	AX-110B-20-S

11. Appendix

11.1. Principle of Blood Pressure Measurement

Measurement procedure : Wrap the cuff around the upper arm. Inflate the cuff to a pressure exceeding the systolic blood pressure. Then, exhaust the air from the cuff gradually. While the pressure is detected in the cuff in the air exhaustion stage, the pulse waveform appears in synchronization with the heartbeat. The pulse waveform suddenly increases near the systolic blood pressure. It increases further with exhaustion until it reaches the highest in amplitude, then decreases gradually. The changes in the pulse waveform are illustrated at next page. In the oscillometric blood pressure measurement, the systolic blood pressure is specified as the point where the amplitude increases suddenly after the pulse in the cuff pressure is detected, the mean blood pressure is specified as the point where the amplitude reaches the highest, the diastolic blood pressure is specified as the point where the amplitude decreases gradually and becomes small. Actually, the pressure sensor detects the subtle changes in the cuff pressure with time, stores the pulse waveform in memory, and evaluates the systolic and diastolic blood pressures according to the oscillometric measurement algorithm. The details in the algorithm vary with the blood pressure monitor. Blood pressure values of adults and infants are measured by the oscillometric method and are compared with those measured by the auscultatory method. Diastolic blood pressure is defined to be the end point of phase 4 in the auscultatory method. The pulse waveform of the cuff pressure depends on the characteristics of the cuff material. Therefore, by using the specified cuff and the measurement algorithm, the measurement accuracy is maintained. Air hose length is within 3.5 m because of the damping characteristics due to pulse wave propagation.

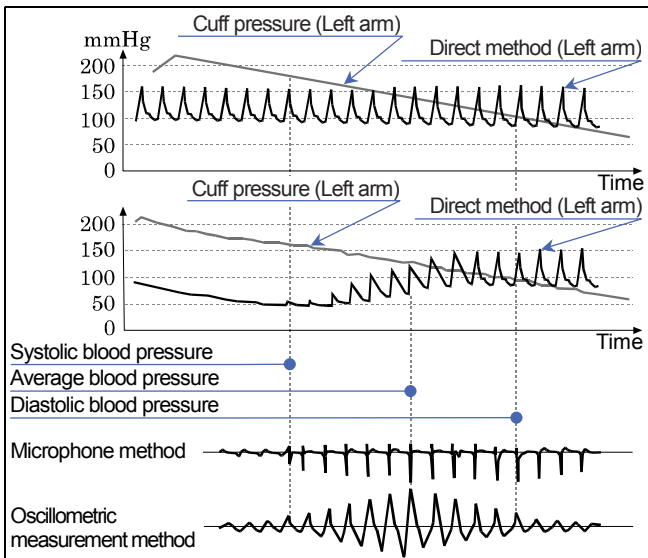

Blood pressure measurement Error factors

The pulse graph can be an objective indicator of the reliability of the measurement accuracy.

When noise occurs due to irregular heart beat or physical movements, the amplitude of the graph changes. When the pulse graph is not a smooth outline, check again or use other methods.

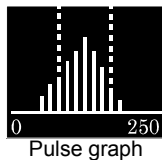

Cuff position at the same height as heart

Wrap the cuff on the arm at the same level as the heart. If the cuff position is incorrect, a measurement error occurs. For example, if the cuff is 10 cm lower than the heart level, the blood pressure is measured 7 mmHg higher.

Proper cuff size

Use a cuff of adequate size. If the size is too small or too big, a measurement error occurs. Measurements with too small a cuff tend to be evaluated as high blood pressure, regardless of the proper blood pressure and normal artery. Measurements with too large a cuff tend to be evaluated as low blood pressure, especially for those who suffer from severe arteriosclerosis or have abnormal arterial valves. The wrong cuff size is a cause of differences between the direct method and oscillometric measurement method. The cuff has the label described range of the arm circumference. Select and attach the proper size cuff for each patient. The accuracy of the blood pressure measurement is guaranteed by the pressure accuracy of the pressure sensor, exhaust characteristics and measurement algorithm, so long as the proper cuff and air hose are used. Inspect the pressure accuracy of the pressure sensor and exhaust characteristics periodically.

11.2. EMC Information

The requirements that apply to medical electronic instruments are described below :

Performance concerning of the EMC guidelines

Medical electrical equipment require special precautions regarding EMC (Electromagnetic compatibility) and must be installed and put into service according to the EMC information provided below. Portable and mobile RF communication equipment (e.g. cell phones) can affect medical electrical equipment.

The recorder is intended for use in the electromagnetic environment specified below. The customer or the user of the recorder should assure that it is used in such an environment.

Accessories compliant with EMC standards

The accessories and options for this recorder accord with the condition of IEC60601-1-2:2007.

Warning



Use accessories designated by the A&D company.
Unauthorized accessories may be influenced by electromagnetic emission and have reduced immunity against disturbances.

RF electromagnetic emissions

Emissions test	Compliance	Electromagnetic environment
RF emissions CISPR11	Group 1	The recorder uses RF energy only for its internal function. Therefore, its RF emissions are very low and are not likely to cause any interference in nearby electronic equipment.
RF emissions CISPR11	Class B	The recorder is suitable for use in all establishments, including domestic establishments and those directly connected to the public low-voltage power supply network that supplies buildings used for domestic purposes.
Harmonic emissions IEC61000-3-2	N.A.	
Voltage fluctuations / flicker emissions IEC61000-3-3	N.A.	

Electromagnetic immunity

Immunity test	IEC60601-1-2 test level	Compliance level	Electromagnetic environment
Electrostatic discharge (ESD) IEC61000-4-2	±6 kV contact ±8 kV in air	±8 kV contact ±15 kV in air	Floors should be wood, concrete or ceramic tile. If floors are covered with synthetic material, the relative humidity should be at least 30%.
Electrical fast transient/burst IEC61000-4-4	±2 kV for power supply lines ±1 kV for input/output lines	N.A.	Does not apply because the built-in power supply unit is built-in.
Surge IEC61000-4-5	±1 kV differential mode ±2 kV common mode	N.A.	
Power frequency (50/60 Hz) magnetic field IEC61000-4-8	3 A/m	30 A/m	Power frequency magnetic fields should become at levels characteristic of a typical location in a typical commercial or hospital environment.
Conducted RF IEC61000-4-6	3 Vrms 150 kHz to 80 MHz	6 Vrms 150 kHz to 80 MHz	Recommended separation distance : $d = 1.2\sqrt{P}$

Immunity test	IEC60601-1-2 test level	Compliance level	Electromagnetic environment
Radiated RF IEC61000-4-3	3 V/m 80 MHz to 2.5 GHz	10 V/m 80 MHz to 2.6 GHz	Recommended separation distance : $d = 1.2\sqrt{P}$ 80 MHz to 800 MHz $d = 2.3\sqrt{P}$ 800 MHz to 2.5 GHz
Voltage dips, short interruptions and voltage variations on power supply input lines IEC61000-4-11	<5 % U_T (>95 % dip in U_T) for 0.5 cycle <40 % U_T (>60 % dip in U_T) for 5 cycle <70 % U_T (>30 % dip in U_T) for 25 cycle <5 % U_T (>95 % dip in U_T) for 5 seconds	N.A.	Does not apply because the power supply unit is built in.

Note : U_T is the AC mains voltage prior to application of the test level.

Electromagnetic environment of Conducted RF and Radiated RF

We recommend that the mobile and portable RF communication instruments are spaced from the transmitter by the recommended separation distance **d** meters (m) or more. This **d** is calculated with the frequency of the transmitter. Where **P** is the maximum output power rating of the transmitter in watts (W) according to the transmitter manufacturer. Field strengths from fixed RF transmitters, as determined by an electromagnetic site survey as **a**, it should be less than the compliance level in each frequency range **b**. Interference may occur in the vicinity of equipment marked with the following symbol :



NOTE 1: At 80 MHz and 800 MHz, the higher frequency range applies.

NOTE 2: These guidelines may not apply in all situations.

Electromagnetic propagation is affected by absorption and reflection from structures, objects and people.

a : Field strengths from fixed transmitters, such as base stations for radio (cellular/cordless) telephones and land mobile radios, amateur radio, AM and FM radio broadcast and TV broadcast cannot be predicted theoretically with accuracy. To assess the electromagnetic environment due to fixed RF transmitters, an electromagnetic site survey should be considered. If the measured field strength in the location in which the recorder is used exceeds the applicable RF compliance level above, the recorder should be observed to verify normal operation. If strange performance is observed, additional measures may be necessary, such as changing position and direction of the recorder.

b : Proper frequency range is 150 kHz to 80 MHz.
Proper field strengths should be less than 3 V/m.

Recommended separation distances

The recorder is intended for use in an electromagnetic environment in which radiated RF disturbances are controlled. Electromagnetic interference can be prevented by maintaining a minimum distance between portable or mobile RF communications equipment (transmitters) and the recorder as recommended below, according to the maximum output power of the communications equipment.

Rated maximum output power of transmitter (W)

	Recommended separation distance d according to frequency of transmitter (m)		
	150 kHz to 80 MHz d = $1.2\sqrt{P}$	80 MHz to 800 MHz d = $1.2\sqrt{P}$	800 MHz to 2.5 GHz d = $2.3\sqrt{P}$
0.01	0.12	0.12	0.23
0.1	0.38	0.38	0.73
1	1.2	1.2	2.3
10	3.8	3.8	7.3
100	12	12	23

For transmitters rated at a maximum output power not listed above, the recommended separation distance **d** in meters (m) can be estimated using the equation applicable to the frequency of the transmitter. Where **P** is the maximum output power rating of the transmitter in watts (W) according to the transmitter manufacturer.



A&D Company, Limited

1-243 Asahi, Kitamoto-shi, Saitama 364-8585, JAPAN

Telephone: [81] (48) 593-1111

Fax: [81] (48) 593-1119

<http://www.aandd.jp>

EC REP

A&D INSTRUMENTS LIMITED

<http://www.andmedical.co.uk/>

Unit 24/26 Blacklands Way, Abingdon Business Park, Abingdon, Oxfordshire
OX14 1DY United Kingdom

Telephone: [44] (1235) 550420

Fax: [44] (1235) 550485

A&D ENGINEERING, INC.

<http://www.andonline.com/medical/>

1756 Automation Parkway, San Jose, California 95131, U.S.A.

Telephone: [1] (408) 263-5333

Fax: [1] (408) 263-0119

A&D AUSTRALASIA PTY LTD

<http://www.andmedical.com.au/>

32 Dew Street, Thebarton, South Australia 5031, AUSTRALIA

Telephone: [61] (8) 8301-8100

Fax: [61] (8) 8352-7409

ООО А&Д РУС

ООО "ЭЙ энд ДИ РУС"

121357, Российская Федерация, г.Москва, ул. Верейская, дом 17

(Business-Center "Vereyskaya Plaza-2" 121357, Russian Federation,

Moscow, Vereyskaya Street 17)

<http://www.and-rus.ru/>

тел.: [7] (495) 937-33-44

факс: [7] (495) 937-55-66

A&D Technology Trading(Shanghai) Co. Ltd

爱安德技研贸易(上海)有限公司

<http://www.aanddtech.cn/>

中国 上海市浦东新区浦东大道 138 号永华大厦 21 楼 A 室 邮编 200120

(21F Room A, Majesty Building, No.138 Pudong Avenue, Pudong New Area,
Shanghai, 200120, China)

电话: [86] (21) 3393-2340

传真: [86] (21) 3393-2347

A&D INSTRUMENTS INDIA PRIVATE LIMITED

ऐ&डी इन्स्ट्रूमेंट्स इण्डिया प्रा० लिमिटेड

<http://www.aanddindia.in/>

509, उद्योग विहार, फेस-5, गुडगांव-122016, हरियाणा, भारत

509, Udyog Vihar, Phase-V, Gurgaon - 122 016, Haryana, India

फोन : 91-124-4715555

फैक्स : 91-124-4715599

CE 0123