

Instructions for use

Upper arm

PROFESSIONELL TOUCH

apo norm[®]
die marke der apotheke



Recognises atrial fibrillation
The most frequent cause of stroke



Also suitable for:



technology by
microlife

aponorm® Professionell Touch – Brief instructions

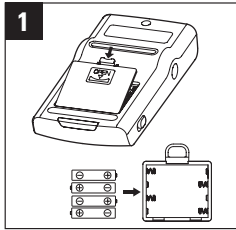

Insert the batteries supplied along with the monitor.

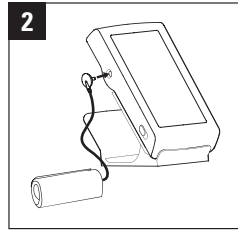

Connect the cuff.

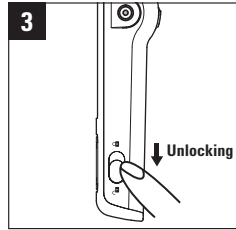

Unlock the monitor by pushing the key lock on the side down.

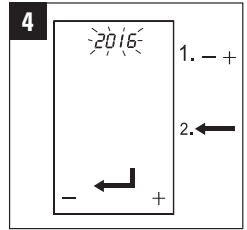

First set the date and time using the "+" and "-" keys. Confirm your selection by pressing Enter.

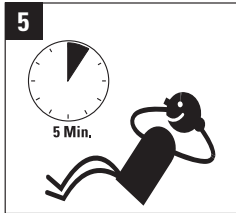

Relax for a few minutes before taking a measurement.

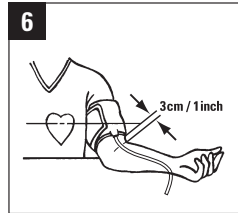

The cuff must be positioned 2 cm above the elbow and at the same height as your heart. Support your arm.

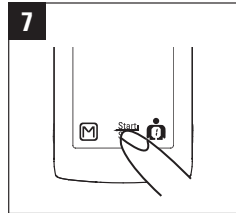

Start your measurement by pressing the Start/Stop button.

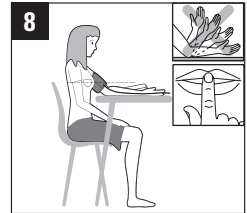

Do not move, talk, eat, drink or smoke while taking the measurement.

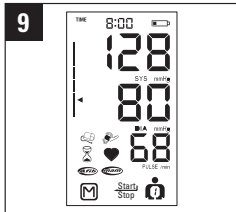

After the measurement the display shows the readout values.



Switch the monitor off. Your values will be memorised automatically.

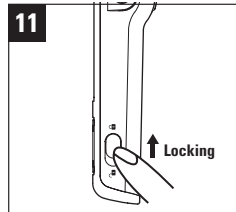

Lock the monitor by pushing the switch upwards.

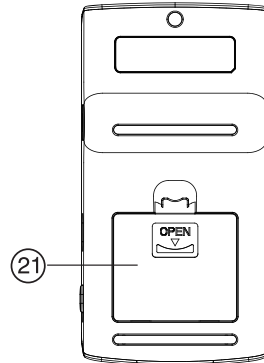
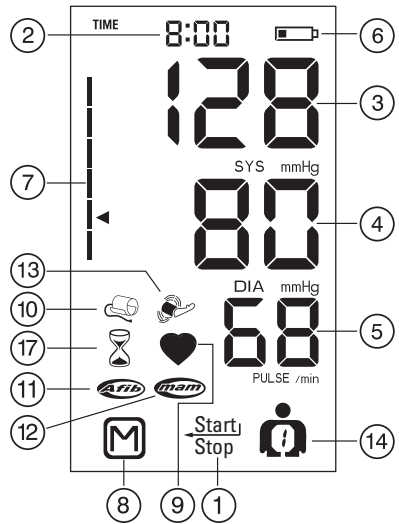
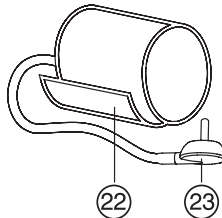
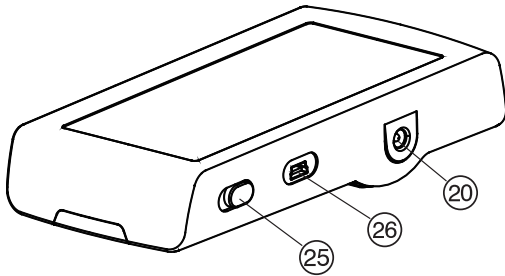
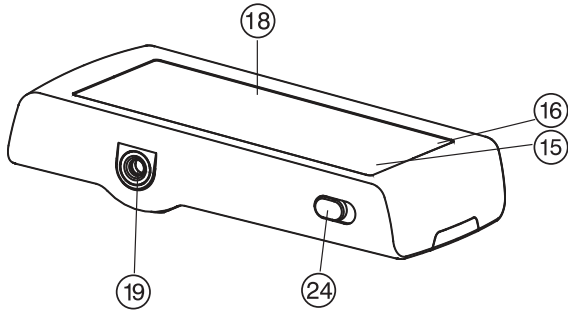

Display shows

- ① Start/stop key (Enter key)
- ② Date/time
- ③ Systolic value
- ④ Diastolic value
- ⑤ Pulse rate
- ⑥ Battery indicator
- ⑦ Blood pressure traffic light
- ⑧ Memory/memory value (M key)
- ⑨ Pulse rate measurement active
- ⑩ Cuff check indicator
- ⑪ Atrial fibrillation (AFIB) warning sign
- ⑫ MAM mode (multiple measurement mode) set
- ⑬ Motion alarm
- ⑭ User switch
- ⑮ "Back" button
- ⑯ "Forward" button
- ⑰ MAM interval pause

Switches, housing and accessories

- ⑱ Touch display
- ⑲ Cuff socket
- ⑳ Mains adapter connector
- ㉑ Battery compartment
- ㉒ Cuff
- ㉓ Cuff connector
- ㉔ AFIB/MAM switch
- ㉕ Locking switch/key lock
- ㉖ USB port



Important! This information must be adhered to in order to prevent damage to the device and error messages.



Protect from moisture



Read the instructions carefully before using this monitor.



Type BF part

Dear Customer,

Your new **aponorm®** by microlife blood pressure monitor is a reliable medical device for taking blood pressure measurements on the upper arm. It is simple to use, accurate and comes highly recommended for blood pressure monitoring in your home. This device was developed in collaboration with physicians and clinical tests carried out prove its measurement accuracy to be of a very high standard.*

aponorm® by microlife AFIB detection is the world's leading blood pressure measurement technology for the detection of atrial fibrillation (AFIB) and hypertension. These are the two top risk factors of getting a stroke or heart disease in the future. It is important to detect AFIB and hypertension at an early stage, even though you may not experience any symptoms. Appropriate treatment will reduce your risk of suffering a stroke. For this reason, it is recommended that you visit your doctor when the device gives an AFIB signal during your blood pressure measurement. The AFIB algorithm of **aponorm®** by microlife has been clinically investigated by several prominent clinical investigators and it showed that the device detects patients with AFIB at a certainty of 97-100%.^{1,2}

Please read through these instructions carefully so that you understand all functions and safety information. We want you to be happy with your **aponorm®** by microlife product. If you have any questions, problems or want to order spare parts please contact the **aponorm®** by microlife Customer Service. Your dealer or pharmacy will be able to give you the address of the **aponorm®** by microlife dealer in your country. For more detailed information on our products please refer to www.aponorm.de.

Stay healthy – **aponorm®** by microlife!

** This device uses the same measuring technology as the award winning "BP 3BTO-A" model tested according to the British Hypertension Society (BHS) protocol.*

¹ Stergiou, G. Ss., Karpettas, N., Protogero, A., Nasothimiou, E. G., and Kyriakidis M.: "Diagnostic accuracy of a home blood pressure monitor to detect atrial fibrillation." *J Hum Hyperten* 2009, 1-5.

² Wiesel J., Fitzig L., Herschman Y., and Messineo F. C.: "Detection of Atrial Fibrillation Using a Modified Microlife Blood Pressure Monitor." *Am J Hypertens* 2009, 848-852.

Table of Contents

1. Important Facts on Blood Pressure and Self-Measurement.....	6
· How do I evaluate my blood pressure?.....	7
2. Important Facts about Atrial Fibrillation (AFIB)	
· What is Atrial Fibrillation (AFIB)?.....	7
· How does AFIB impact my family or me?.....	8
· microlife AFIB detection provides a convenient way to screen for AFIB (only in MAM mode).....	8
· Risk factors you can control yourself.....	8
3. Using the Device for the First Time	
· Inserting the batteries.....	8
· Setting the date and time.....	8
· Selecting the correct cuff.....	9
· Selecting the user.....	9
· Select the measuring mode: standard or MAM mode.....	9
· MAM mode (highly recommended).....	10
4. Taking a Measurement with this Monitor...10	
· Ccheck list for taking a reliable measurement...10	
· Not storing a reading.....	11
5. Indication of Atrial Fibrillation for Early Diagnosis (only in MAM Mode).....	11
6. “Traffic Light” Indicator in the Display.....	12
7. PC Link Functions.....	12
· Installation and data transmission.....	13
8. Data Memory.....	13
· Viewing the stored readings.....	13
· Memory full.....	13
· Clearing all readings.....	14
9. Battery Indicator and Battery Change.....	14
· Low battery.....	14
· Flat batteries - replacement.....	14
· Which batteries and which procedure?.....	14
· Using rechargeable batteries.....	14
10. Using a Mains Adapter.....	15
11. Error Messages.....	15
12. Safety, Care, Accuracy Test and Disposal...16	
· Safety and protection.....	16
· Device care.....	17
· Cleaning the cuff.....	17
· Accuracy test.....	17
· Disposal.....	17
13. Warranty.....	17
14. Technical Data.....	19
Warranty card (see back cover)	

1. Important Facts about Blood Pressure and Self-Measurement

- Blood pressure is the pressure of the blood flowing in the arteries generated by the pumping of the heart. Two values, the **systolic** (upper) value and the **diastolic** (lower) value, are always measured.
- The monitor also indicates the **pulse** rate (the number of times the heart beats in a minute).
- **Permanently high blood pressure values can damage your health and must be treated by your doctor!**
- Always discuss your values with your doctor and tell him/her if you have noticed anything unusual or feel unsure. **Never rely on the blood pressure readings alone.**
- **There are several causes** of excessively high blood pressure values. Your doctor will explain them in more detail and offer treatment where appropriate. Besides medication, weight loss and exercise can also lower your blood pressure.
- **Under no circumstances should you alter the dosages of any drugs prescribed by your doctor!**
- Depending on physical exertion and condition, blood pressure is subject to wide fluctuations as the day progresses. **You should therefore take your daily measurements in the same quiet conditions and when you feel relaxed!** Take at least two measurements per day (one in the morning and one in the evening).
- It is quite normal for two measurements taken in quick succession to produce significantly **different results**. Therefore we recommend to use the MAM technology.
- **Deviations** between measurements taken by your doctor or in the pharmacy and those taken at home are quite normal, as these situations are completely different.
- **Several measurements** provide much more reliable information about your blood pressure than just one single measurement.
- Leave a **small break** of at least 15 seconds between two measurements.
- If you suffer from severely **irregular heart beat (cardiac arrhythmia)**, you should have the readings evaluated by your doctor.
- **The pulse display is not suitable for checking the frequency of heart pacemakers!**

- If you are **pregnant**, you should monitor your blood pressure very closely as it can change drastically during this time!

 This blood pressure monitor is specially tested for use in pregnancy and for pre-eclampsia. When you detect unusual high readings in pregnancy, you should measure again after 4 hours. If the reading is still too high, consult your doctor or gynaecologist.

How do I evaluate my blood pressure?

Table for classifying home blood pressure values in adults in accordance with the international guidelines (ESH, AHA, JSH). Data in mmHg.

The higher value is the one that determines the evaluation. Example: a blood pressure value of **140/80** mmHg or a value of **130/90** mmHg indicates “blood pressure too high”.

Range	Systolic	Dias-tolic	Recommendation
Blood pressure too low	↓ 100	↓ 60	Consult your doctor!
1. Blood pressure optimum	100 - 130	60 - 80	Self-check
2. Blood pressure elevated	130 - 135	80 - 85	Self-check
3. Blood pressure too high	135 - 160	85 - 100	Seek medical advice
4. Blood pressure far too high	160 ↑	100 ↑	Urgently seek medical advice!

2. Important Facts about Atrial Fibrillation (AFIB)

What is Atrial Fibrillation (AFIB)?

Normally, your heart contracts and relaxes to a regular beat. Certain cells in your heart produce electrical signals that cause the heart to contract and pump blood. Atrial fibrillation occurs when rapid, disorganized electrical signals are present in the heart’s two upper chambers, called the atria;

causing them to contract irregularly (this is called fibrillation). Atrial fibrillation is the most common form of heart arrhythmia or irregular heart beat. It often causes no symptoms, yet it significantly increases your risk of stroke. You'll need a doctor to help you control the problem.

How does AFIB impact my family or me?

Persons having atrial fibrillation run 5 times the risk of suffering a stroke.

Since the chance of having a stroke increases with age, individuals above the age of 55 years benefit most from screening for AFIB. However, for younger individuals with risk factors such as diabetes or hypertension screening for AFIB is also recommended. Early diagnosis of AFIB followed by adequate treatment can significantly reduce the risk of getting stroke. Younger individuals with AFIB have a relatively low risk of getting stroke as compared to elder people.

The AFIB recognition of aponorm® by microlife can indicate atrial fibrillation (only in MAM mode). Knowing your blood pressure and knowing whether you or your family members have AFIB can considerably help reduce the risk of stroke. AFIB recognition by aponorm® by microlife provides a convenient way to screen for AFIB whilst taking your blood pressure.

Risk factors you can control

High blood pressure and AFIB are both considered “controllable” risk factors for strokes. Knowing your blood pressure and knowing whether you or members of your family have AFIB is the first step in proactive stroke prevention.

3. Using the Instrument for the first Time

Inserting the batteries

First switch the Lock Switch ④ to the “unlock” position. Then insert the batteries. The battery compartment ② is at the bottom of the device. Insert the batteries (4 x size AAA 1.5 V), observing the indicated polarity (+/-).

Setting the time and date

1. After having inserted the batteries, wait until a beep is heard and the year starts to flash in the display. You can set the year by pressing either the “+” ⑩ or the “-” ⑪ button. Confirm the year by pushing the Enter button ①.
2. Now you can set the month by pressing either the “+” or the “-” button. Again press Enter to confirm the month.
3. Now set the day, hours and minutes analogously to the process described in steps 1 and 2.

- After you confirmed the minute value, the set time is shown in the display (the date stored is required only for readings stored in the memory).
- If you want to change the date and time, press and hold the time button down for approx. 3 seconds until the year number starts to flash. Then you can perform steps 1 to 3 all over again.

Selecting the correct cuff

aponorm® by microlife offers different cuff sizes. Select the cuff size to match the circumference of your upper arm (measured close fitting in the centre of the upper arm).

Cuff size	for circumference of upper arm
S	17 - 22 cm
M	22 - 32 cm
M – L	22 - 42 cm
L	32 - 42 cm
L – XL	32 - 52 cm

 Use only **aponorm**® by microlife cuffs!

- ▶ Connect the cuff to the monitor by inserting the cuff connector ⑫ into the cuff socket ⑩ as far as it will go.

Selecting the user

This monitor allows to store the measuring results for 2 individual users. In addition, the monitor can accommodate a guest user (guest mode). This mode does not transfer the blood pressure readings to the memory.

Before each measurement please set the monitor to user "1", user "2" or "-" (guest mode).

- For this purpose press the user symbol ⑭ until the number in the symbol starts flashing.
- Now you can select the desired user by again pressing the user symbol (user "1", "2" or "-" if you do not want to store the reading in the guest mode).
- Wait for about 2 to 3 seconds until the symbol stops flashing.

Selection of the measuring mode: standard or MAM mode

This monitor allows you to select one of two measuring modes: standard (standard individual measurement) or MAM mode (automatic triple measurements).

To select standard mode, slide the AFIB/MAM switch ⑮ on the side of the device downwards to position "1", and to select MAM mode, slide this switch upwards to position "3".

MAM mode (highly recommended)

In the MAM mode, three measurements are performed one after the other; the average reading is calculated and displayed as the result. Because blood pressure constantly fluctuates, a result determined in this way is more reliable than one produced by a single measurement.







AFIB detection is only activated in MAM mode.

- After you pressed the Start/Stop button ①, the automatic triple measurements start, which is indicated by the MAM symbol ② in the display.
- The bottom, right hand section of the display shows a 1, 2 or 3 to indicate which of the 3 measurements is currently being taken.
- There is a break of 15 seconds between the measurements (15 seconds are adequate according to "Blood Pressure Monitoring, 2001, 6:145-147" for oscillometric instruments). A count down indicates the remaining time.
- The individual results are not displayed. Your blood pressure will only be displayed after all 3 measurements are taken.
- Do not remove the cuff between measurements.
- If one of the individual measurements was questionable, a fourth one is automatically taken.

4. Taking a Measurement with this Monitor



Check list for taking a reliable measurement

1. Avoid activity, eating or smoking immediately before the measurement.
2. Sit down for at least 5 minutes before the measurement and relax.
3. Always measure on the same arm (normally left) and when seated. It is recommended that doctors perform double arm measurements on a patient's first visit in order to determine which arm to measure in the future. It is the arm with the higher blood pressure which should be always be measured.
4. Remove close-fitting garments from the upper arm. To avoid constriction, shirt sleeves should not be rolled up. They do not interfere with the cuff if they are laid flat.
5. Always ensure that the correct cuff size is used (marking on the cuff).
 - Fit the cuff closely, but not too tight.
 - Make sure that the cuff is positioned 2 cm above the elbow.
 - The artery mark located on the cuff (approx. 3 cm long bar) must lie over the artery which runs down the inner side of the arm.

- Support your arm so it is relaxed.
 - Ensure that the cuff is at the same height as your heart.
6. Switch the Lock Switch  to the “unlock” position. Press the Start/Stop button  to start measuring.
 7. The cuff will now pump up automatically. Relax, do not move and do not tense your arm muscles until the measurement result is displayed. Breathe normally and do not talk.
 8. When the correct pressure is reached, the pumping stops and the pressure falls gradually. If the required pressure was not reached, the instrument will automatically pump some more air to the cuff.
 9. During the measurement, the heart icon  is flashing.
 10. The result, comprising the systolic  and the diastolic  blood pressure and the pulse rate  is displayed. Note also the explanations on further displays in this booklet.
 11. When the device has finished measuring, remove the cuff.
 12. Switch off the monitor (the display will switch off automatically after approx. 1 minute).

Not storing a reading

Press the Start/Stop button  while the measuring result is displayed. Keep the button pressed until the M button  starts flashing. The release the button for a short time and confirm by again shortly pressing the M button.

 You can stop the measurement at any time by pressing the Start/Stop button  (e.g. if you feel uneasy or an unpleasant pressure sensation).

5. Indication of Atrial Fibrillation for Early Detection (only in MAM mode)

This device is able to detect atrial fibrillation (AFIB). This symbol  indicates that atrial fibrillation was detected during the measurement. If AFIB is present during blood pressure measurement, the AFIB indicator is displayed flashing at the end of the triple measurements.

It is highly recommended to take an additional MAM measurement an hour later to confirm the result. If after repeated measurement the AFIB symbol is no longer displayed there is no cause for concern. In such case it is recommended to measure again the next day.

However, if the symbol appears on a regular basis (e.g. several times a week with measurements taken daily) we advise you to visit your doctor. Please provide the following explanation:

Information for the doctor on frequent appearance of the absolute arrhythmia (atrial fibrillation) indicator.

This device is an oscillometric blood pressure monitor that also analyses pulse frequency during measurement. The monitor was subjected to a clinical study.

If atrial fibrillation occurred during the triple measurements (MAM mode), the AFIB symbol for atrial fibrillation is displayed after the measurement series. If the symbol appears more frequently (e.g. several times per week on measurements performed daily) we recommend the patient to seek medical advice, to be on the safe side.

The device does not replace a cardiac examination, but serves to detect atrial fibrillation that often remains undiagnosed until stroke occurs.

 Keep the arm still during a repeat measurement to avoid false readings.

 This device cannot detect atrial fibrillation in people with pacemakers or defibrillators.

6. “Traffic Light” Indicator in the Display

The bars on the left-hand edge of the traffic light display  show you the range within which the indicated blood pressure value lies. Depending on the height of the bar, the readout value is either within the optimum (green), elevated (yellow), too high (orange) or dangerously high (red) range. The classification corresponds to the 4 ranges in the table as defined by the international guidelines (ESH, AHA, JSH), as described in “Chapter 1”.

7. PC Link Functions

This device can be used in conjunction with a personal computer (PC) running the “**aponorm**®” by microlife Blood Pressure Analyser (BPA)”. The memorised data can be transferred to the PC by connecting the monitor to the PC via a cable.

If no CD and cable is included, download the BPA software from www.aponorm.de and use a USB cable with a Mini-B 5 pin connector.

 **Important:** The software supplied will ONLY run on a Windows operating system. You will also find a beta version for MAC PCs under www.aponorm.de.

Please set the date/time on your blood pressure monitor before data synchronisation so that any memorised readings can later on be properly as-

signed and displayed in the analysing programme. If no date/time was set on the device, a correct transfer/display of the memorised values from the monitor to the software programme is not possible. For information on setting the date/time see Chapter 3.

Installation and data transmission

1. Insert the CD into the CD ROM drive of your PC. The installation will start automatically. If not, please click on "SETUP.EXE" in the CD menu.
2. Connect the blood pressure monitor to you PC using a cable. You do not even need to switch on your monitor. 3 horizontal bars will appear on the display and last for 3 seconds.
3. The bars will flash to indicate that the connection between PC and monitor is successful. As long as the cable is plugged in, the bars will keep flashing and the buttons are disabled.



 Please refer to the download section under www.aponorm.de for a more detailed instruction on installation and initial initiation of the software programme. After installation and initiation please also read the menu item "Help".

 During the connection, the device is completely controlled by the computer. Please refer to the menu item "Help" in the software instructions.

8. Data Memory

This device automatically stores up to 99 measurement values for each of the 2 users.

Viewing the stored values



Using the user symbol , first set the user whose readings you want to access in the memory. Then press the M button  for a short time. The display first shows the average of all readings stored, which is indicated by an "A" (= Average) in the bottom right corner of the display. The monitor then switches over to the last result stored. You can now switch to the individual readout values by pressing the M button several times.

Memory full



Please note that the maximum memory capacity is 99 values per user. **When the 99 value memory is full, the oldest value is automatically overwritten with the 100th value.** Values should be evaluated by a doctor before the memory capacity is reached – otherwise data will be lost.

Clearing all values

1. First unlock the monitor (Lock Switch  in "open" position). Via the user symbol  select the user whose data you want to delete.
2. Hold down the M button  until "CL" appears and then release the button.

3. Press the M button again while “CL” is flashing to permanently clear all values.

 Stopping the clearing process: Press the Start/Stop button ① while “CL” is flashing.

 It is not possible to clear individual readings.

9. Battery Indicator and Battery Change

Low battery

When the batteries are approximately $\frac{3}{4}$ empty the battery symbol ⑥ will flash as soon as the device is switched on (partly filled battery displayed). Although the monitor will continue to measure reliably, you should obtain replacement batteries.

Flat batteries – battery replacement

When the batteries are flat, the battery symbol ⑥ (flat battery) will flash as soon as the monitor is switched on. You cannot take any further measurements and must replace the batteries.

1. Open the battery compartment ⑳ at the bottom of the monitor.
2. Replace the batteries – ensure correct polarity as shown by the symbols in the compartment.
3. To again set date and time, follow the procedure described in “Chapter 3”.

 The memory retains all values although date and time must be reset.

Which batteries and which procedure?

 Use 4 new, long-life alkaline, 1.5V, size AAA batteries.

 Do not use batteries beyond their date of expiry.

 Remove batteries if the device is not going to be used for a prolonged period.

Using rechargeable batteries

You can also operate this device using rechargeable batteries.

 Only use “NiMH” type reusable batteries.

 Batteries must be removed and recharged when the flat battery symbol appears. They must not remain inside the instrument, as they may become damaged (total discharge as a result of low power consumption of the monitor, even when switched off).

 Always remove the rechargeable batteries if you do not intend to use the device for a week or more.

 Batteries CANNOT be charged in the blood pressure monitor.

 Recharge batteries in an external charger and observe the information regarding charging, care and durability.

10. Using a Mains Adapter

You can operate this device using the **aponorm®** by microlife mains adapter (DC 6V, 600mA).

 Use only the **aponorm®** by microlife mains adapter available as an original accessory appropriate for your supply voltage.

 Ensure that neither mains adapter nor cable are not damaged.

1. Plug the adapter cable into the mains adapter socket ^⑩ in the blood pressure monitor.
2. Plug the adapter plug into the wall socket.

When the mains adapter is connected, no battery current is consumed.

11. Error Messages

If an error occurs during the measurement, the measurement is interrupted and an error message, e.g. **“ERR 3”** is displayed.

Error	Designation	Potential cause and remedy
“ERR 1”	Signal too weak	The pulse signals on the cuff are too weak. Reposition the cuff and repeat the measurement.*
“ERR 2” ^⑬	Error signal	During the measurement, error signals were detected by the cuff, caused for instance by movement or muscle tension. Repeat the measurement, not moving your arm.
“ERR 3” ^⑩	No pressure in the cuff	An adequate pressure cannot be generated in the cuff. A leak may have occurred. Check that the cuff is correctly connected and is not too loose. Replace the batteries if necessary. Repeat the measurement.

Error	Designation	Potential cause and remedy
"ERR 5"	Abnormal result	The measuring signals are inaccurate and no result can therefore be displayed. Read through the check list for performing reliable measurements and then repeat the measurement*
"ERR 6"	MAM mode	There were too many errors during the measurement in the MAM mode, making it impossible to obtain a final result. Read through the check list for performing reliable measurements and then repeat the measurement.*
"HI"	Pulse or cuff pressure too high	The pressure in the cuff is too high (over 300 mmHg) OR the pulse is too high (over 200 beats per minute). Relax for 5 minutes and repeat the measurement.*
"LO"	Pulse too low	The pulse rate is too low (less than 40 beats per minute). Repeat the measurement.*

* Please consult your doctor, if this or any other problem occurs repeatedly.

 If you think the results are unusual, please read through the information in "Chapter 1" carefully.

12. Safety, Care, Accuracy Test and Disposal

Safety and protection

- This monitor may not be used for purposes other than those described in these instructions. The manufacturer cannot be held liable for damage caused by incorrect application.
- This blood pressure monitor contains sensitive components and must be handled carefully. Observe the storage and operating conditions described in the "Technical Data" chapter!
- Protect the monitor from:
 - ▶ water and moisture
 - ▶ extreme temperatures
 - ▶ impact and falls
 - ▶ dirt and dust
 - ▶ direct sunlight
 - ▶ heat and cold
- The cuff is rather delicate and must be handled carefully.
- Do not use any other type of cuff or cuff connector for measuring with this device.

- Inflate the cuff only when fitted to your arm.
- The function of this monitor can be impaired by strong electromagnetic fields as emitted by mobile telephones or radio installations. We recommend observing a minimum distance of 1 metre. If you cannot maintain the minimum distance please check the proper function of the device before use.
- Do not use the monitor if you think it is damaged or notice anything unusual.
- Never open the monitor.
- If the device is not going to be used for a prolonged period the batteries should be removed.
- Please observe the additional safety information in the different chapters of these instructions.



Do not let unsupervised children use the monitor. Some of the components are so small that children can swallow them or choke on them. Beware of the risk of strangulations in case this monitor is fitted with cables or tubes.

Device care

Only clean the monitor with a soft and dry cloth.

Cleaning the cuff

Carefully remove spots on the cuff with a damp cloth and soapsuds.

 **WARNING:** Do not wash the cuff in a washing machine or dishwasher!

Accuracy test

We recommend this device is tested for accuracy every 2 years or after mechanical impact (e.g. being dropped). Please contact the **aponorm®** by microlife service to arrange the test (see foreword).

Disposal



Batteries and electronic devices must be disposed of in accordance with the locally applicable regulations, not with domestic waste.

13. Warranty

We are convinced of the high quality of our aponorm® blood pressure monitors. Therefore we, WEPA Apothekenbedarf GmbH & Co. KG, grant end customers who are consumers, a voluntary 5 year warranty for all aponorm® blood pressure monitors purchased in Germany, subject to the proviso below:

1. Subject matter and scope of the warranty

The warranty applies to any aponorm® blood pressure monitor which the customer purchased in Germany as a consumer. WEPA Apothekenbedarf GmbH & Co. KG warrants the customer that the product is free of material and manufacturing defects. If despite proper handling of the product

a defect occurs within the 5 year warranty period, WEPA Apothekenbedarf GmbH & Co. KG will repair the product free of charge (with the exception of the transport cost for returning the monitor) or will replace it at WEPA's discretion.

2. Exclusion of warranty

No claims under this warranty can be raised in the event of damage caused by customer's own fault or third-party fault, e.g. fall, accident or improper handling. The same applies to defects resulting from leaking batteries or failure to observe the instructions. Warranty by WEPA Apothekenbedarf GmbH & Co. KG is also excluded if a defect/damage is due to improper repair or other interference by a third party.

The warranty does not cover wear parts, accessories (e.g. pouches, cables, etc.), batteries and the cuff coming with the monitor.

We grant a function warranty (air tightness of the bladder) of 2 years.

3. Warranty period

The warranty applies for a period of five years from the date of purchase (warranty period). The decisive date is the date of the sales receipt or of the warranty card filled in by the dealer indicating the date of purchase.

The warranty period is not extended due to services provided under this warranty, in particu-

lar not in the event of repair or exchange of the product. In these cases, the warranty does not start anew, either.

4. Assertion of claims

The customer can assert the rights under this warranty by presenting the defective product and the sales receipt or the warranty card filled in by the dealer within the warranty period directly to WEPA Apothekenbedarf GmbH & Co. KG or to the dealer where they purchased the product.

In the event of a warranty case, WEPA Apothekenbedarf GmbH & Co. KG will repair the product free of charge (with the exception of the transport cost for returning the monitor) or fully replace it at WEPA's discretion.

If the check yields that the damage does not come under the warranty, the product can be repaired by WEPA Apothekenbedarf GmbH & Co. KG at customer's expense. In this case WEPA Apothekenbedarf GmbH & Co. KG informs the customer of the estimated cost in a quotation before even starting the repair. In this case the customer is free to order the repair of the product at customer's expense or request the return of the damaged/unrepaired product.

5. Further rights of customer

WEPA Apothekenbedarf GmbH & Co. KG grants the warranty subject to the conditions stipulated.

The customer may, furthermore, have further legal rights. This warranty does not affect the customer's contractual and legal rights, in particular the legal warranty rights vis-à-vis the seller of the product.

The law of the Federal Republic of Germany applies to this warranty. Date: 07/2016

14. Technical Data

Operating conditions:	10 - 40 °C / 50 - 104 °F 15 to 95% relative maximum air humidity
Storage conditions:	-20 to +55 °C / -4 to +131 °F 15 to 95% relative maximum air humidity
Weight:	312 g (including batteries)
Dimensions:	160 x 82 x 35 mm
Measuring method:	oscillometric, validated by the Korotkoff method: phase I systolic, phase V diastolic
Measuring range:	20 - 280 mmHg – blood pressure 40 - 200 beats per minute – pulse

Display range cuff pressure:	0 - 299 mmHg
Measuring resolution:	1 mmHg
Static accuracy:	pressure within ± 3 mmHg
Pulse accuracy:	± 5 % of the readout value
Voltage source:	<ul style="list-style-type: none">• 4 x 1.5 V alkaline batteries, size AAA• Mains adapter 6V DC, 600 mA (optional)

Battery life:	approx. 400 measurements (with new batteries)
IP class:	IP 20
Reference to standards:	EN 1060-1 /-3 /-4; IEC 60601-1; IEC 60601-1-2 (EMC); IEC 60601-1-11
Average life:	Monitor: 5 years or 10,000 measurements Accessories: 2 years

This device complies with the requirements of the Medical Device Directive 93/42/EEC.

Technical alterations reserved.

aponorm® Professionell Touch – Warranty pass card

Customer name

Monitor serial number (SN)

--	--	--	--	--	--	--	--	--

Purchase date

Pharmacy stamp and
signature

Warranty pass card

To be on the safe side: our aponorm® by microlife warranty.

Your new blood pressure monitor is a top-class precision medical device.
We are convinced of its high quality and therefore, from the date of purchase, we grant a



Please refer to page 16 of the instructions for the terms of warranty in detail.

Tip:

In case you lost the instructions for use with the terms of warranty during your period of use of the device, you can at any time download them at www.aponorm.de.

apornorm[®]

die marke der apotheke

Overview of the device functions:

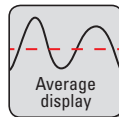
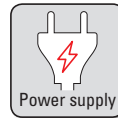
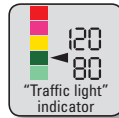
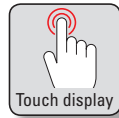
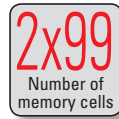
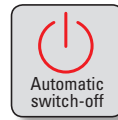
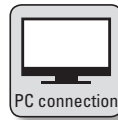

WEPA

DIE APOTHEKENMARKE

Sold by:

WEPA Apothekenbedarf
GmbH & Co KG

Am Fichtenstrauch 6 - 10

D-56204 Hillscheid

www.apornorm.de

www.wepa-dieapothekenmarke.de

microlife[®]

Manufactured by:

Microlife AG

Espenstrasse 139

CH-9443 Widnau

www.microlife.ch

Order No. 047245



PZN -12393720

CE0044

