

Codefree

3 IN 1 BLOOD GLUCOSE MONITOR step by step



german engineering



Contents

1 Getting to know your instrument	4
1.1 Delivery scope, replacements and accessories.....	5
1.2 Functions of the device.....	6
1.3 Signs and symbols.....	7
2 Warnings and safety notes	8
3 Description of units and accessories	11
3.1 Blood glucose monitor.....	11
3.2 Lancing device and lancet needles.....	12
3.3 USB cover.....	12
3.4 Display symbols.....	12
3.5 Test strips.....	13
4 Initial use and basic settings	14
4.1 Removing the battery insulation strips, replacing the batteries.....	14
4.2 Making and changing basic settings	15
5 Taking measurements	16
5.1 Preparing to take a blood sample	16
5.2 Preparing the lancing device for taking a sample.....	17
5.3 Taking a blood sample and measuring the glucose level	19
5.4 Reading the result and labelling measurements	21
5.5 Post-processing and disposal	22
5.6 Evaluating measured blood glucose values.....	23
5.7 Functional check using control solution	25
6 Measurement memory	28
6.1 Displaying individual values	28
6.2 Displaying average blood glucose values.....	29
6.3 Displaying average blood glucose values for labelled values.....	29
6.4 Deleting individual measured values from the memory	31
6.5 Deleting all stored values	31
6.6 Evaluating measured values on a PC	31
7 Storing, maintaining and disinfecting the device	32
7.1 Maintenance	32
7.2 Disinfection	32
8 What if there are problems?	33
9 Technical specifications	35
10 Guarantee and customer service	38

1 GETTING TO KNOW YOUR INSTRUMENT

Dear customer,

Thank you for choosing one of our products. Our name stands for high-quality, thoroughly tested products for applications in the areas of heat, weight, blood pressure, blood glucose measurement, body temperature, pulse, gentle therapy, massage and air.

Please read these Instructions for use carefully and keep them for later use, be sure to make them accessible to other users and observe the information they contain.

With kind regards,
Your Beurer team.

Getting to know your instrument

The GL50 blood glucose monitor is intended for fast and simple blood glucose measurement of fresh capillary blood samples, either for self-testing or in a clinical environment by trained personnel.

It enables you to measure your blood glucose quickly and easily, store the measured values and display the average of all measured values, thereby providing optimum assistance for monitoring your diabetes. The test is performed exclusively externally (IVD).

The backlit display shows measured values clearly. The user-friendly design with handy test strips and the simple controls with just a small number of buttons guarantee simple, yet reliable measurements.

The device can be connected directly to a PC using the integrated USB connection. You can evaluate the measured values on your PC using special software (in English and German) and use the results to monitor your blood glucose values.

1.1 Delivery scope, replacements and accessories

Check that the set packaging has not been tampered with and make sure that all contents are present. Before use, ensure that there is no visible damage to the device or accessories and that all packaging material has been removed. If you have any doubts, do not use the device and contact your retailer or the specified Customer Services address.

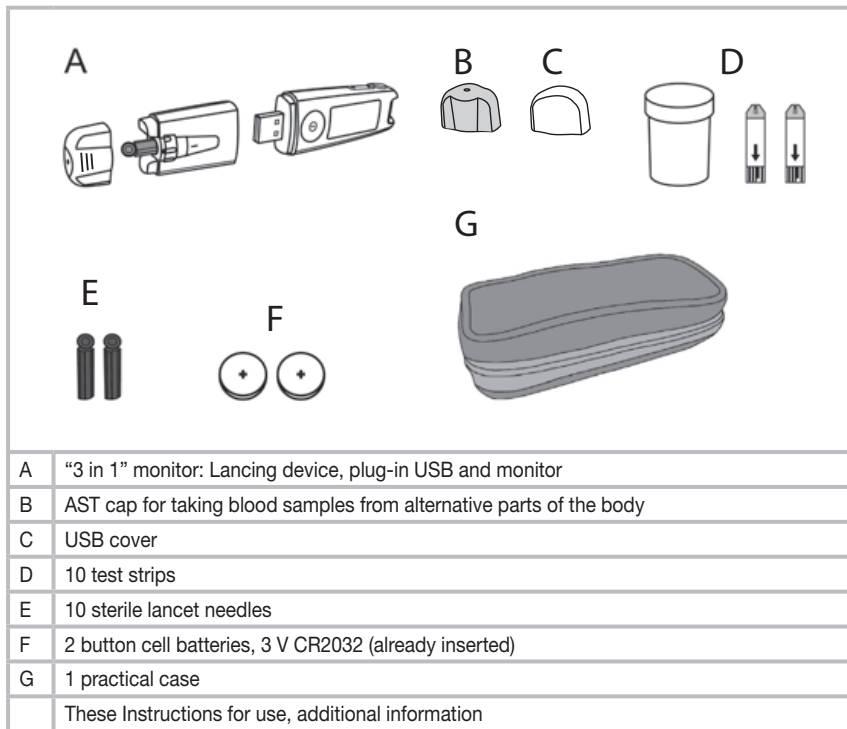

- The blood glucose monitor (A), test strips (D) and additionally available control solutions have been specially designed to complement each other. For this reason, use only test strips (D) and control solutions that have been approved for this blood glucose monitor (A).

Note

- Use original manufacturer accessories only.

Follow-up purchases

You can also obtain test strips, control solution and lancet needles without a prescription.

Item	REF
50 test strips	REF 464.15
Control solution LEVEL 3 and 4	REF 464.16
100 lancet needles	REF 457.01

1.2 Functions of the device

This device is intended for measuring the blood glucose content in human blood. It is also suitable for self-testing at home.

The blood glucose monitor enables you to quickly and simply:

- Measure your blood glucose level
- Display, label and save measured values
- Display the average measured blood glucose value from the last 7, 14, 30 and 90 days
- Display the average of the labelled measured blood glucose values from the last 7, 14, 30 and 90 days
- Set the time and date
- Evaluate the saved measured values on a PC using special software.

The blood glucose monitor also includes the following monitoring functions:

- Warning in the event of unsuitable temperatures
- Low battery display
- Low test strips warning



















Warning

- **Do not use the device to diagnose diabetes; it is intended for regular monitoring only.**
- **Consult your GP with regard to insulin doses.**

1.3 Signs and symbols

The symbols on the packaging, type plate of the blood glucose monitor and accessories represent the following:

 IVD	In vitro diagnostics		Manufacturer
 SN	Serial number		Please observe the Instructions for use
 2°C 30°C	Temperature limit +2°C to +30°C		PCT: certification symbol for products that are exported to the Russian Federation and members of the CIS
	Not for re-use/For single use only		Green dot (Der Grüne Punkt): German dual waste collection system
	Use by		Contents sufficient for <n> tests
	Maximum shelf life after initial opening in months		Order number
 LOT	Batch designation		Unit of measurement for blood glucose value
 STERILE R	Sterilised by radiation (lancets)		Biohazard, risk of infection
	Warning, see accompanying documents		

In the Instructions for use, the symbols represent the following:

 **Warning**

Warning instruction indicating a risk of injury or damage to your health/your patient's health.

 **Important**

Safety note indicating possible damage to the unit/accessory.

 **Note**

Note on important information

2 WARNINGS AND SAFETY NOTES

Risk of infection

All components of the blood glucose monitor and its accessories may come into contact with human blood and are therefore a possible source of infections.



Warning

- **This blood glucose monitor must display the blood glucose content in mg/dL. The unit of measurement mg/dL accompanies each blood glucose value. Please contact Customer Services if the device does not display mg/dL. You risk damaging your health if you measure your blood glucose value using a unit of measurement with which you are not familiar, misinterpret the values and therefore take incorrect measures.**
- When using the blood glucose monitor for various persons, observe the generally applicable regulations regarding disinfection, safety and contamination.
- Medical carers and others who use this system on several patients must be aware that all products or objects that come into contact with human blood must be handled, even after cleaning, as though they could transfer pathogens.
- The lancing device is suitable for self-testing. Do not share the lancing device or lancet needles with others or amongst various patients (**risk of infection!**).
- Use a new, sterile lancet needle for each blood sample (**for single use only**).

General notes



Warning

Do not use the device in the vicinity of strong electromagnetic fields and keep it away from radio systems or mobile telephones.

Measuring the blood glucose content



Warning

- The measurements taken by you are for your information only – they are no substitute for a medical examination! Consult your GP regularly regarding your measured values. Do not alter the procedures prescribed by your GP.
- The Beurer GL50 monitor provides a simple way of monitoring your own blood glucose levels, however, you may need to obtain information on how to use the system from your healthcare professional (for example, your GP, chemist or diabetes consultant). Only proper use will guarantee precise measurements.
- A lack of water, high fluid loss, for example perspiration, frequent passing of water, severe hypotension (low blood pressure), shock or hyperosmolar hyperglycaemic non-ketotic coma (HHNKC) may lead to incorrect measured results.

- An excessively high or low hematocrit value (proportion of red blood cells) may lead to incorrect measurements. In the event of a very high hematocrit value (above 55%), the displayed blood glucose value may be too low; in the event of a very low hematocrit value (below 30%), it may be too high. Consult your GP if you do not know your hematocrit value.
- Do not use the test strips to measure blood glucose values on newborns.
- Do not use NaF or potassium oxalate anticoagulants to prepare for venous blood samples.
- Do not test any severely ill patients using this device.
- Lipemia effects: High blood triglyceride values of up to 1000 mg/dL have minimum influence on the results. However, triglyceride values above this level may affect the blood glucose test.
- High blood cholesterol values of up to 500 mg/dL have minimum influence on the results. However, cholesterol values above this level may affect the blood glucose test.
- Use fresh capillary whole blood only. Do not use serum or plasma.
- Use capillary blood without squeezing the penetration area. If the area is squeezed, the blood is diluted with tissue fluid and this may lead to an incorrect result.
- Do not use the test strips above an altitude of 7010 m.
- Very high levels of humidity may influence the test results. Relative humidity of more than 90% may lead to inexact results.



Note

The Beurer GL50 mg/dL measuring system is intended for measuring capillary whole blood.

Storage and maintenance



Warning

- Store the blood glucose monitor and its accessories out of reach of small children and pets. Small parts, such as lancet needles, batteries or test strips may be life-threatening when swallowed. If swallowed, seek medical attention immediately.
- The test strip box contains desiccant, which may irritate the skin or eyes when inhaled or swallowed. Keep the box out of the reach of children.

The blood glucose monitor is made from precision and electronic components. The accuracy of the measurements and service life of the device depend on its careful handling:

- Protect the device and its accessories from impacts, humidity, dirt, marked temperature fluctuations and direct sunlight. Do not store the device, test strips and control solution in your vehicle, in the bathroom or in a cooling appliance.
- Do not drop the device.

Batteries/Saving measured values



Warning

- Keep batteries out of reach of children. Children may put batteries in their mouth and swallow them. This may severely damage their health. In such cases, seek medical assistance immediately!
- Normal batteries must not be charged, heated or thrown into an open fire (**risk of explosion!**).



Important

- Batteries must not be taken apart or short circuited.
- Always replace all batteries at the same time and use batteries of the same type.
- Leaking batteries may damage the device. If you do not intend to use the device for longer periods, remove the batteries from the battery compartment.

Attention!

- Leaking or damaged batteries may burn the skin therefore use suitable protective gloves if this is the case.



Note

- The stored blood glucose values are retained when the batteries are replaced. If applicable, the date and time must be reset after replacing the batteries.
- Use lithium-ion batteries only.

Repairs



Note

- Do not open the device. Failure to comply will result in voiding of the warranty.
- Do not repair the device. Proper operation can no longer be guaranteed in this case.
- Please contact Customer Services for repairs.

Disposal



Warning

- It is essential to comply with the generally applicable safety precautions for handling blood when disposing of materials from the blood glucose monitor. Dispose of all blood samples and materials with which you or your patients come into contact correctly in order to prevent injury and infection of other persons.
- After use, dispose of test strips and lancets in a puncture-proof container.



Note

Batteries must not be disposed of with household waste. As a consumer, you are required by law to recycle used batteries. You can recycle your old batteries at public collection points in your community or wherever batteries of the relevant type are sold.

The codes below are printed on batteries containing harmful substances:

- Pb = Battery contains lead,
- Cd = Battery contains cadmium,
- Hg = Battery contains mercury.

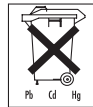

For environmental reasons, do not dispose of the device in the household waste at the end of its useful life. Please dispose of the unit in accordance with EC Directive 2002/96/EC – WEEE (Waste Electrical and Electronic Equipment). If you have any questions, please contact the local authorities responsible for waste disposal.



3 DESCRIPTION OF UNITS AND ACCESSORIES

3.1 Blood glucose monitor

An overview of the monitor

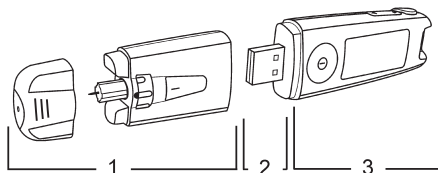

- 1 Lancing device
- 2 Plug-in USB
- 3 Monitor

Front

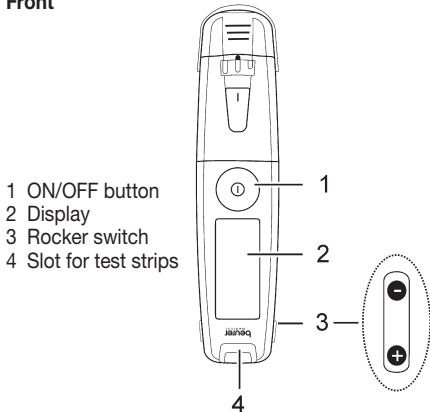

- 1 ON/OFF button
- 2 Display
- 3 Rocker switch
- 4 Slot for test strips

Rear

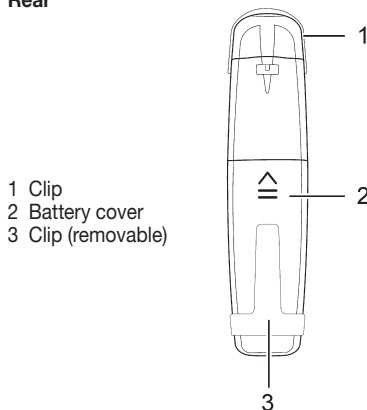

- 1 Clip
- 2 Battery cover
- 3 Clip (removable)

3.2 Lancing device and lancet needles

- 1 AST cap (transparent)
- 2 Cap
- 3 Protective lancet disc
- 4 Sterile lancet needles
- 5 Lancet holder
- 6 Dial for setting different penetration depths
- 7 Tensioning slider
- 8 Trigger

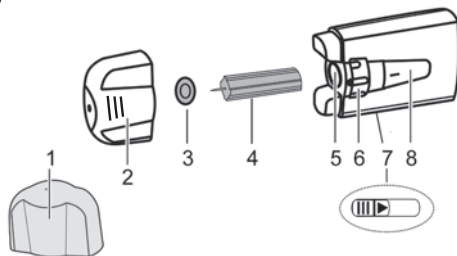

3.3 USB cover



If you would like to use the blood glucose monitor without the integrated lancing device, you can use the supplied USB cover in place of the lancing device.

3.4 Display symbols

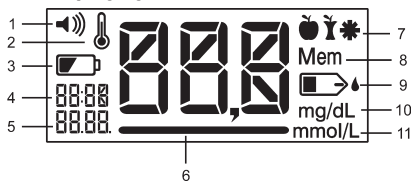

- 1 Speaker symbol
- 2 Temperature symbol
- 3 Replace battery symbol
- 4 Time
- 5 Date
- 6 Measured value display, HI, LO display, average blood glucose value, ERR, USB
- 7 Symbols for labelling measurements
- 8 Memory symbol
- 9 Test strip and blood droplet symbol
- 10 Blood glucose unit mg/dL
- 11 Blood glucose unit mmol/L – not functional

Note

To read the measured values correctly, the underline must be below the measured values.

Note

The blood glucose monitor is supplied with the following basic settings:

- Blood glucose unit: mg/dL
- Acoustic signal on
- Backlighting on

3.5 Test strips

Front

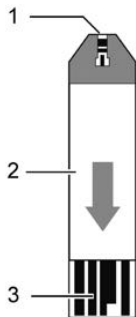

- 1 Gap for blood input
- 2 Handle
- 3 Contacts

Insert the test strip into the device so that the contacts are pointing inside the slot.

Make sure that the front of the test strip is facing you.

Note

Read carefully the following information on handling and storing your test strips. The test strips will only provide accurate measured results if all notes are followed.

Warning

Use each test strip only **once** and for **one** patient only!

Handling test strips

Note



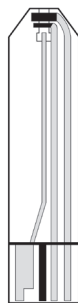

- Securely close the test strip box immediately after taking out a test strip.
- Do not use the test strips if they have expired. The use of expired test strips may lead to incorrect measurements. The expiry date is printed on the box next to the hourglass symbol .

Rear

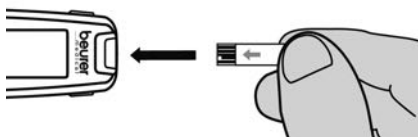

You can identify the rear by the contact tracks.



- Test strips expire three months after the box is opened. Make a note of the expiry date (opening date + 3 months ) on the label. The shelf life is limited to the expiry date (see date next to the hourglass symbol )).
- Discontinue use of the test strips if one of the two expiry dates has passed ( / ).
- You can touch any part of the test strip with clean, dry hands.
- Use the test strip for measurement immediately after removing it from the box.
- Do not bend, cut or otherwise modify the test strips.
- Do not use test strips that have come into contact with fluids.

Storing test strips

Note

- Keep the test strips in a cool, dry place above +2°C and below +30°C. Do not expose the test strips to direct sunlight or heat. Do not store in your vehicle, in the bathroom or in a cooling appliance.
- Permitted relative air humidity below 90%.
- Keep the test strips in the original box only – never use other containers.

4 INITIAL USE AND BASIC SETTINGS

4.1 Removing the battery insulation strips, replacing the batteries

Note

- Two batteries are included with the blood glucose monitor. These have already been inserted into the battery compartment.
- Remove the insulation strip before initial use.

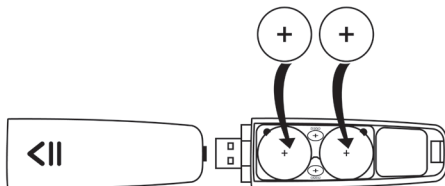

- 1 Carefully pull the lancing device and monitor apart. Then detach the removable clip.
- 2 Remove the battery compartment lid on the underside of the device. To do so, slide the cover in the direction of the imprinted arrow.
- 3 When replacing the batteries, remove all batteries. The device retains the date and time as long as one battery is still inserted. If applicable, reset the date and time (see "4.2 Making and changing basic settings" on page 15).
- 4 Insert two new **CR 2032 3 V** batteries. Make sure that the batteries are inserted the correct way round. See the graphic in the battery compartment.
- 5 Close the battery compartment lid again carefully.

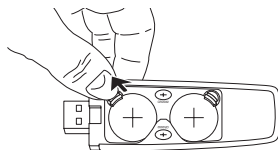

- 6 Reattach the clip to the rear of the monitor. Fit the lancing device and monitor back together.

Note

- If the replace battery symbol  appears, it means that the batteries are almost empty. Replace both batteries as soon as possible.
- If “LP” appears on the display, the battery power level is so low that no more measurements can be taken.

4.2 Making and changing basic settings

- 1 Remove the batteries and reinsert them. Alternatively, hold down the “+” button and the ON/OFF button for a minimum of five seconds.
An acoustic signal sounds.
The year display flashes.



- 2 **Setting the date and time**

Note

- You must set the date and time. Otherwise, you will not be able to save your measured values correctly with a date and time and access them again later.
- The time is displayed in the 24-hour format.

Set the year (calendar to 2099) by pressing the “+” or “-” button. Confirm by pressing the ON/OFF button.

The day display flashes.

Proceed as described above for the month, day, hour and minute.

“d5P LIt” and “on” are displayed. The background of the display is simultaneously illuminated for a few seconds.

- 3 **Switch backlighting on/off**

To switch the blue backlighting off, press the “+” or “-” button.

“d5P LIt” and “OFF” are displayed. Confirm by pressing the ON/OFF button.

“bEEP”, “on” and the speaker symbol are displayed.

- 4 **Switching the acoustic signal on/off**

To switch the acoustic signal off, press the “+” or “-” button.

“bEEP” and “OFF” are displayed.

The speaker symbol is no longer shown in the display.

Confirm by pressing the ON/OFF button.

“OK” and “Mem” are displayed.

5 Deleting stored values

Proceed as follows to delete stored values:

- Press the “+” or “-” button. “Mem” and “dEL” are displayed
- Confirm by pressing the ON/OFF button. “Mem” and “dEL” flash in the display.
- To irreversibly delete your values, press the ON/OFF button again to confirm. “Mem”, “dEL” and “OK” are displayed.

If you do not wish to delete your values, press the “+” or “-” button. “Mem” and “OK” are displayed again. Confirm by pressing the ON/OFF button.

- 6 The blood glucose monitor is now ready for use.

5 TAKING MEASUREMENTS



Warning

- If the protective disc on a lancet needle has already been removed, do not use the lancet needle.
- If you drop the lancing device with an inserted lancet needle, carefully pick it up and dispose of the lancet.



Important

- Use the lancing device only with lancet needles from the same manufacturer. Using other lancet needles may prevent the lancing device from working properly.
- If you are using a third-party lancing device, please read the accompanying Instructions for use.

5.1 Preparing to take a blood sample

1 Choose a part of the body from which to take a blood sample

The lancing device is intended for taking blood samples from the fingertip or other body parts such as the palm of the hand, forearm or upper arm. We recommend taking blood samples from the fingertip. To make the procedure as painless as possible, do not take samples directly from the centre of the fingertip, but slightly to either side.



Warning

- **In the event of suspected hypoglycaemia: take blood from the fingertip only.** Reason: changes to blood glucose levels can be detected quickly in blood samples taken from the fingertip.
- Blood samples from the fingertip and samples taken from another body part (AST) may produce completely different results. It is essential to seek medical advice before taking measurements from other body parts.

2 Prepare all parts

Prepare the following items: GL50 monitor (A), test strip box (D) and sterile lancet needles (E). You will also need the AST cap for measurements on other parts of the body (B).

3 Wash your hands

Wash your hands with soap and warm water before taking a blood sample. This not only ensures optimal hygiene but also encourages good blood circulation at the puncture area on the finger. Dry your hands carefully. Also ensure that the puncture area is hygienically clean when taking blood samples from other body parts (AST).



Warning

If you have used alcohol for cleaning, ensure that the area has fully dried prior to measuring.

5.2 Preparing the lancing device for taking a sample

1 Remove cap

First bend the clip backwards.

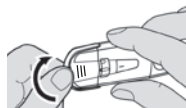

Hold the monitor by the lancing device cover in one hand. With your other hand, remove the cap from the lancing device.

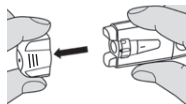

2 Insert lancet needle

Insert a sterile lancet needle into the lancing device.

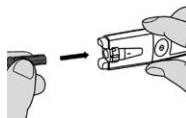

Push firmly on the lancet until it audibly engages and it cannot be pushed further into the holder.

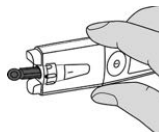

3 Remove the protective lancet disc

Remove the protective lancet disc by turning clockwise. Retain the protective disc for the safe disposal of the used lancet needle after taking a blood sample.

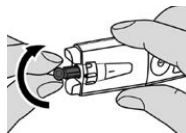

4 Select cap and attach.

You need to use a different cap depending on the area from which you take the sample:

- **Fingertip:** Cap (black)
- **Other body parts:** AST cap (transparent)



Warning

Do not use the AST cap to take blood samples from the finger.

Place the selected cap on the lancing device. Make sure that the curved part of the cap fits on the curved part of the lancing device. Press firmly on the cap until it audibly engages.



5 Select the penetration depth

You can set seven different penetration depths on the lancing device using the dial with raised bars. The length of the bar represents the required penetration depth.

- 1 to 2: soft or thin skin
- 3 to 5: normal skin
- 6 to 7: thick or callous skin

Turn the dial until the required bar is in the centre of the black marking.



6 Tension the lancing device

Pull the slider in the direction of the arrow (to the right in the image) until it stops and then release. The slider automatically springs back into position. The lancing device is now tensioned.

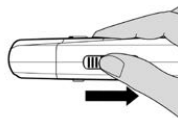

5.3 Taking a blood sample and measuring the glucose level



Warning

- Change the puncture area each time you take a measurement, e.g. use a different finger or the other hand. Repeatedly using the same area may cause inflammation or scarring.
- If the cap is not in place, there is a risk of injury from the exposed lancet.
- Do not squeeze your finger to obtain a larger drop of blood. If squeezed, the blood is diluted with tissue fluid and this may lead to an incorrect result.
- Please note that insufficient blood circulation at the puncture area, e.g. caused by cold temperatures or illness, can lead to incorrect results.



Important

Do not apply any blood samples or control solutions to the test strip before inserting it in the monitor.

1 Prepare the test strip

Take a test strip from the box and immediately close it again. Use the test strip within three minutes of removing it from the box.

2 Insert test strip

Take the monitor in your left hand. Hold the blood glucose monitor so that the display is facing you and the Beurer logo is on the right-hand side.

Insert the test strip into the slot on the rear end of the blood glucose monitor with the contacts first. Make sure that the front of the test strip is facing you. You can touch any part of the test strip with clean, dry hands.

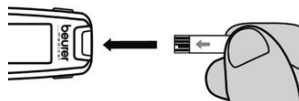

3 The device switches on automatically

The device switches on automatically and briefly shows the full display. The device is ready for use as soon as the test strip symbol and the flashing blood droplet symbol are displayed.



Warning

If segments are missing, stop using the device and immediately contact customer services. To test whether the full display is completely displayed, pull the test strip out of the device and hold the On/Off button when subsequently switching on the device.

4 Lancing to take a blood sample

The lancing device can now be used to take a blood sample. Make sure that the blood remains as a droplet and is not spread.

- Blood sample from the fingertip

Firmly position the lancing device slightly to the side of the centre of the fingertip. Press the trigger. Remove the lancing device from the finger. A round drop of blood of at least 0.6 microlitres (corresponds to approx. 1.4 mm, original size: ●) must have formed.

- Blood sample from other body parts (AST)

Find a soft area away from any bones, without any visible blood vessels and with as little hair as possible. Warm the penetration area to enhance circulation by gently massaging the area. Press and hold the lancing device against the penetration area for a few seconds and then press the trigger. Continue to hold the lancing device against the skin until a round drop of blood has formed under the cap. Maintain the pressure until the drop of blood reaches a size of at least 0.6 microlitres (corresponds to approx. 1.4 mm, original size: ●). Carefully remove the lancing device from the skin.

Note

Only take blood from other areas of the body at the following times:

- On an empty stomach (more than two hours after most recent meal).
- At least two hours after administration of insulin.
- At least two hours after physical activity.

Please also note the following:

- If the blood glucose test results do not match how you feel, carry out another test using blood from your fingertip.
- DO NOT change your treatment purely on the basis of a measurement that was carried out using blood taken from an alternative area. Carry out another test with blood from your fingertip in order to confirm the test result.
- If you often fail to notice that you have a low blood glucose level, carry out a test using blood from your fingertip.

5 If necessary, repeat the process

If you do not obtain sufficient blood, repeat the lancing process with a greater penetration depth in a different area.

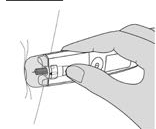
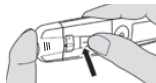

6 Apply blood to the test strip

Turn the monitor by 180°. Hold the blood input gap (at the tip of the test strip) to the drops of blood until the gap is completely filled and the monitor in the display starts counting backwards.

Do not press the penetration area (fingertip or other body parts) to the test strip. The blood must not be spread. The blood is sucked into the gap.

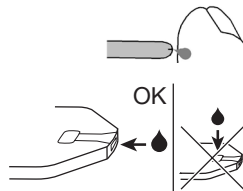

i Note

Error message “Err002” appears on the display if the gap was not correctly and sufficiently filled with blood. Repeat the measurement using a new test strip and a greater penetration depth.

i Note

- Do **not** add blood later if the device does not start measurement. Remove the test strip and end this test. Use a new test strip.
- If the test strip has already been inserted into the device but no blood is added to the test strip within two minutes, the device switches itself off. Briefly remove the test strip and reinsert it so that the device automatically switches itself back on.
- Contact Customer Services if you are unable to cover the test strip in blood correctly.

5.4 Reading the result and labelling measurements

Read the result

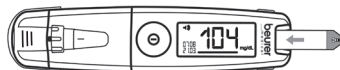

Hold the blood glucose monitor so that the display is facing you (Beurer logo on the right-hand side). As soon as the blood input gap is filled with sufficient blood, the device performs the blood glucose measurement. The blood glucose monitor counts down for approx. five seconds. The measured result is then shown on the display.



Read your measured value. Check again that you have read the result correctly. The underline must be below the measured value, otherwise you need to turn the monitor by 180°. For explanations of and measures regarding the measured values, see “5.6 Evaluating measured blood glucose values” on page 23. If an error message is displayed, read chapter “8. What if there are problems?” on page 33.

Label measured value

You have the following options for labelling measured values.

	Before a meal
	After a meal
	General label (e.g. after exercising)

Labelling measured values enables you, your GP or diabetes consultant to better monitor your blood glucose values. For example, you can display the average values of all measurements taken before a meal.

To label a measurement, proceed as follows:

- 1 The measured value can be labelled as soon as it is displayed. Once the value disappears from the display, it can no longer be labelled.
- 2 Press the “-” rocker switch repeatedly.
 - Pressing once, adds the label 🍏 “Before a meal”.
 - Pressing again, adds the label 🍴 “After a meal”.
 - Pressing a third time, adds the label * “General label”.
 - Pressing a fourth time removes the label.
- 3 The selected label is stored in the memory of the device when it is switched off.

5.5. Post-processing and disposal

- 1 **Remove test strip**
Remove the test strip from the device and carefully dispose of it in accordance with the applicable regulations to avoid infecting others.
- 2 **Remove cap**
Carefully remove the cap from the lancing device.

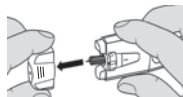

3 Stick protective disc on needle

Place the retained protective disc flat on a hard surface. Stick the tip of the needle into the protective disc (image 1) so the needle is covered (image 2).



Image 1

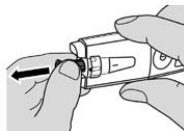

Image 2

4 Remove and dispose of lancet needle

Press the trigger again so that you can grip the shaft. Carefully remove the lancet needle from the lancing device and dispose of the lancet in a puncture-proof container.

Carefully dispose of all blood samples and materials that you have come into contact with. This prevents injuries and the infection of others.



5 Replace cap

Place the cap back on the device. Turn the clip back over the cap.

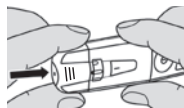

5.6 Evaluating measured blood glucose values

Your blood glucose monitor can process values between 20 and 630 mg/dL. The “Lo” warning is displayed for measured results below 20 mg/dL. The “Hi” warning is displayed for measured results above 630 mg/dL.



Warning

- If you suspect that the blood glucose results are incorrect, first repeat the test and, if applicable, perform a functional test using control solution. Seek medical advice if dubious results persist.
- Seek medical attention immediately if your symptoms do not correspond to your measured blood glucose values and you have followed all instructions for the Beurer GL50 blood glucose monitor.
- Do not ignore symptoms of too high/low blood glucose levels. Always seek medical attention!

Blood glucose

The following table provides a classification of blood glucose values according to the diabetes guidelines of the German Diabetes Association (Deutsche Diabetes Gesellschaft – DDG).

Time of blood glucose measurement	Normal blood glucose values	Suspicion of diabetes	Diabetes
On an empty stomach			
• Whole blood, capillary (haemolysed)	Below 90 mg/dL	90 – 109 mg/dL	≥ 110 mg/dL
• Plasma venous	Below 100 mg/dL	100 – 125 mg/dL	≥ 126 mg/dL
Two hours after a meal	Below 140 mg/dL	140 – 199 mg/dL	≥ 200 mg/dL

Source: German Diabetes Association (Deutsche Diabetes Gesellschaft – DDG) 2009

Critical blood glucose values

Display	Blood glucose	Actions
	Very low blood glucose level Below 20 mg/dL	Seek medical attention immediately.
	Low blood glucose level Below 70 mg/dL	Have a suitable snack. Follow your GP's instructions.
	High blood glucose level <ul style="list-style-type: none">• On empty stomach, over 100 mg/dL• Two hours after a meal, over 140 mg/dL	If this high value persists two hours after your last meal, this may indicate hyperglycaemia. Seek medical attention to coordinate any measures, if applicable.
	High blood glucose level, possibly ketones Above 240 mg/dL	Perform a ketone test. For this purpose, seek medical attention.
	Very high blood glucose level Above 630 mg/dL	Take another measurement using a new test strip. If the display is the same as before: seek medical attention immediately.

5.7 Functional check using control solution

The control solution is used to test the entire blood glucose monitoring system. This helps to determine whether the monitor and the test strips are working optimally together and whether the test is being performed correctly.

Perform the control solution test if you suspect that the blood glucose monitor and/or the test strips could be faulty or if you have repeatedly measured unusual blood glucose values. Also test the blood glucose monitor if it has been dropped or is damaged. The control solution is available separately. Please observe the additional notes in the instructions for using the control solution for the test.



Important

- Do not use third-party control solution. Correct functioning of your monitor can only be tested using Beurer LEVEL3 + LEVEL4 control solutions.
- Control solution measurements: When using the device, specialist personnel must follow statutory guidelines.
- Do not apply any blood samples or control solutions to the test strip before inserting it in the monitor.

Performing a functional test using control solution



Warning

To obtain correct results, the monitor, test strip and control solution must be the same temperature. For the “Functional test using control solution”, the temperature is to be between 20 °C and 26 °C.

1 Insert test strip

Hold the blood glucose monitor so that the display is facing you. Insert a test strip into the slot on the blood glucose monitor with the contacts first. Make sure that the front of the test strip is facing you (see 3.4 “Test strips” on page 13).

2 Wait until the device is ready for use

The device automatically switches on and briefly shows the initial display. The device is ready for use as soon as the test strip symbol and the flashing blood droplet symbol  are displayed.

IMPORTANT: Control solutions and blood react to temperature influences in different ways. It is therefore of vital importance that control solution measurement is always performed in control solution mode. If this mode is not used, results may be obtained that are outside the target range.

3 Activate control mode

Press the rocker switch (“+” or “-”) to change to control mode. “ \square ” is shown on the display. In control mode, the measured value is not saved, meaning your statistics will not be affected. However, if you do want to save the control measurement in the memory, press the rocker switch (“+” or “-”) again. “ \square ” disappears from the display.

4 Drip control solution on surface

Choose a clean surface to carry out the functional test correctly. Shake the control solution well before use. Undo the cap and press two drops next to each other on the clean surface without touching them. Use the second drop for the measurement.



Never apply the control solution straight from the bottle to a test strip. Reason: The remaining solution in the bottle will be contaminated if the top of the bottle comes into contact with the test strip.

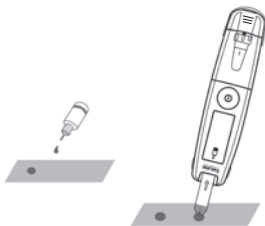

5 Apply drop to the test strip

Hold the input gap (at the tip of the test strip) to the drop of control solution until the gap is completely filled. When the gap is sufficiently filled with solution, the device performs a measurement. The device counts down for approx. five seconds. The measured result is then shown on the display.

6 Evaluate result of functional test

Check whether the result is within the specified range of results for the control solution. This range of results is printed on the test strip box.

Expected results

At room temperature, the measured values from the test using the control solution should be within the range printed on the test strip box in approx. 95% of all tests.



Warning

The result range printed on the test strip box applies only to the control solution. **This is not a recommended value for your blood glucose level.**

If measured values are outside the specified range, check the following possible causes:

Cause	Action
<ul style="list-style-type: none">• The first drop of control solution was not disposed of.• The tip of the bottle was not cleaned correctly.• The bottle was not shaken well enough.	Rectify the cause and repeat the test.
Control solution or test strip is contaminated.	Repeat the test using a new bottle of control solution and/or new test strip.
The control solution, test strip or blood glucose monitor is too warm or too cold.	Bring the control solution, test strips and blood glucose monitor to room temperature (+20°C to +26°C) and repeat the test.
The test strips and control solution were kept at a temperature and humidity outside the specified range.	Repeat the test using new, correctly stored accessories (test strips and control solution).
Damaged test strips. Possible causes include <ul style="list-style-type: none">• Test strips were exposed to fresh air for too long.• Test strip box was not closed completely.	Repeat the test using a new test strip and/or a new box of correctly stored test strips.
Test strip or control solution has expired.	Repeat the test using a new bottle of control solution and/or new test strip from a new box.
Functional test using control solution was performed incorrectly.	Repeat the test and follow the instructions.
Problem with the blood glucose monitor	Contact Customer Services.



Warning

If you repeatedly obtain measured values outside the specified range when using control solution, **discontinue using the system to measure your blood glucose level.** Contact Customer Services.

6 MEASUREMENT MEMORY

For each measurement, your blood glucose value is automatically saved with the date and time unless “CLL” was activated for a blood glucose measurement using control solution.

The memory can store a maximum of 480 measured values. If the memory is full, the oldest value is replaced by the most recent value. You can call up every individual measured blood glucose value. You can also calculate and display the average value for the last 7, 14, 30 and 90 days.

Note

- If you have already saved measured values and you reset the date, the average values are calculated as from the new period.
- “---” indicates an empty memory for measured values. Press the ON/OFF button to switch off the device.

6.1 Displaying individual values

The individual values from the last 480 measurements are displayed. The most recent measured value is displayed first, and the oldest last. The date and time are also displayed on the monitor at the same time.

- 1 Switch the monitor on using the on/off button [1]. The initial display is shown briefly. Press the “+” or “-” rocker switch [3].
- 2 “Mem” and the number of saved blood glucose tests are displayed briefly (Image 1). The display then changes to the most recent saved value including the measurement unit, date, time, “Mem” and any label (Image 2).



Image 1



Image 2

- 3 Each time you press the rocker switch “-” again, first the memory space number will be displayed and then the relevant measured value. You can display a maximum of 480 previous measurements.
- 4 You can cancel the process at any time. To do so, press the ON/OFF button or wait until the device switches itself off automatically after two minutes.

6.2 Displaying average blood glucose values

You can display the average measured blood glucose value from the last 7, 14, 30 and 90 days.

- 1 Switch the monitor on using the on/off button [1]. The initial display is shown briefly. Press the “+” rocker switch twice [3]. The measurement unit of the blood glucose value, “07 d” and the average value are displayed (this means: 07 = 7, d = days).
- 2 Press “+” repeatedly to display the average value for 7, 14, 30 and 90 days.
- 3 You can cancel the process at any time. To do so, press the ON/OFF button or wait until the device switches itself off automatically after two minutes.

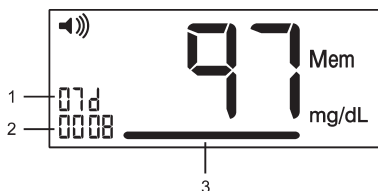

- 1 Number of days, e.g. 7, for which the average value is calculated
- 2 Number of saved values used to calculate the average, e.g. 8
- 3 Average value

6.3 Displaying average blood glucose values for labelled values

You can display the average measured blood glucose value for labelled values from the last 7, 14, 30 and 90 days.

- 1 Switch the monitor on using the on/off button [1]. The initial display is shown briefly. Press the “+” rocker switch twice [3]. The measurement unit of the blood glucose value, “07 d” and the average of all measured values are displayed (this means: 07 = 7, d = days).

2 Press “+” repeatedly to display the average value of all measured values for 14, 30 and 90 days.

After the average of all measured values for 90 days is displayed,

- the seven-day average for values measured “before a meal”
- the 🍏 symbol
- the unit of measurement for blood glucose values and
- “07 d”

are shown on the display.



Press “+” repeatedly to display the average blood glucose level from the last 14, 30 and 90 days taken “before a meal” 🍏.

After the average value for 90 days taken “before a meal” 🍏 is displayed,

- the seven-day average for values measured “after a meal”
- the 🍷 symbol
- the unit of measurement for blood glucose values and
- “07 d”

are shown on the display.



Press “+” repeatedly to display the average blood glucose level from the last 14, 30 and 90 days taken “after a meal” 🍷.

After the average value for 90 days taken “after a meal” 🍷 is displayed,

- the average for the last seven days of values labelled as “general”
- the 🌟 symbol
- the unit of measurement for blood glucose values and
- “07 d”

are shown on the display.



Press “+” repeatedly to display the average blood glucose level from the last 14, 30 and 90 days for values labelled as “general” 🌟.

3 You can cancel the process at any time. To do so, press the ON/OFF button or wait until the device switches itself off automatically after two minutes.

6.4 Deleting individual measured values from the memory

- 1 Press the buttons as described in “6.1 Displaying individual values” on page 28 until the value that you would like to delete is displayed.
- 2 Press and hold the ON/OFF button. Also press the “-” button for two seconds. “dEL”, “Mem” and the number of the value to be deleted flash. Press the ON/OFF button again. “dEL”, the number of the value to be deleted, “Mem” and “OK” are displayed. If you do not wish to delete the value, briefly press the “+” or “-” button. You are taken back to the memory area.
- 3 The device then indicates that the subsequent measured value has moved to the memory space of the deleted measured value.

6.5 Deleting all stored values

Proceed as described in “4.2 Making and changing basic settings” under the section entitled “Deleting stored values” on page 16.

6.6 Evaluating measured values on a PC

The GL50 monitor features an integrated plug-in USB stick. The blood glucose evaluation software GlucoMemory is installed on the USB stick (for position of the USB connection, see page 11). The GL50 is compatible with Diabass and SiDiary.

The blood glucose evaluation software GlucoMemory is pre-installed on the monitor’s USB stick. You do not need to install the software locally on a PC. This software enables you to evaluate your measured values, add insulin doses and print or export your results as a PDF or CSV file. The software helps you and your GP to better monitor your blood glucose level.

For more information, please read software manual for the GlucoMemory software. Including all the necessary information and a detailed description of how to use the software (in English and German).

Note

- An effective evaluation is only possible if you have set the date and time correctly (see “Setting the date and time” on page 15).
- Measurements cannot be taken while the USB stick is connected to a PC.
- The measurements remain saved on the blood glucose monitor when the USB stick is removed from the PC.
- It is not possible to save software entries on the USB stick; Values are read only.

Evaluating measured values on the PC

- 1 The blood glucose monitor must be switched off. Insert the monitor's USB connector into a free USB port on your PC. In the event that the measuring device is not recognised, please try using another active USB point.
- 2 "USB" is shown on the display of the blood glucose monitor. Saved data can now be viewed on your PC.
- 3 See the information on evaluating values in the software manual.

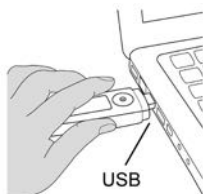

7 STORING, MAINTAINING AND DISINFECTING THE DEVICE

Storing

Keep the Beurer GL50 blood glucose monitor in the case supplied after each measurement and do not expose it to direct sunlight.

Note

- Do not store the device, test strips and control solution in your vehicle, in the bathroom or in a cooling appliance.
- Retain these Instructions for use.
- Remove the batteries if you do not intend to use the device for a prolonged period of time.
- Only clean the device when it is switched off.

7.1 Maintenance

Clean the surface of the device using a soft, slightly damp cloth (water or a mild cleaning solution). Dry the device using a lint-free cloth.

Make sure that moisture does not enter the test strip insertion slot. Do not spray cleaning agent directly on the device. Do not submerge the device in water or any other fluids and make sure that no fluids can enter the device.

7.2 Disinfection

Please comply with the generally applicable guidelines on disinfection when using the device on different persons. Do not submerge the device in disinfection solutions or any other fluids and make sure that no fluids can enter the device.

The cap on the integrated lancing device can be disinfected with 70–75% alcohol. Disinfect the cap at least once a week and submerge the cap in alcohol for approx. 10 minutes. Allow the cap to air dry.

Note

The blood glucose monitor is made of precision components. The accuracy of the measurements and service life of the device depend on its careful handling:

- Protect the device from impacts and do not drop it.
- Protect the device from damaging factors such as moisture, dirt, dust, blood, control solution or water, marked temperature fluctuations, direct sunlight and extreme cold.
- Do not use the device in the vicinity of strong electromagnetic fields, radio systems or mobile telephones.

8 WHAT IF THERE ARE PROBLEMS?

Display messages on batteries and blood glucose measurement

No.	Cause	Solution
LP	Batteries empty.	Replace all batteries.
Ht	Temperature of the measuring environment, blood glucose monitor or test strip above the permitted range.	Repeat the test using a new test strip as soon as the measuring environment, blood glucose monitor and test strips have reached room temperature (+20°C to +26°C).
Lt	Temperature of the measuring environment, blood glucose monitor or test strip below the permitted range.	Repeat the test using a new test strip as soon as the measuring environment, blood glucose monitor and test strips have reached room temperature (+20°C to +26°C).
Err 	Used or contaminated test strip inserted.	<ul style="list-style-type: none">• Insert an unused test strip that has not expired.• Repeat the blood glucose measurement.
Err 001	System error.	Remove batteries, reinsert batteries. Contact Customer Services if the problem persists.
Err 002	Insufficient blood on the test strip.	Repeat the measurement using a new test strip.
Err 005	System error.	Remove batteries, reinsert batteries. Contact Customer Services if the problem persists.
	Unknown error messages.	Remove batteries, reinsert batteries. Contact Customer Services if the problem persists.

Problem: device does not switch on

Cause	Solution
Batteries empty.	Replace batteries.
Incorrectly inserted or missing batteries.	Check whether the batteries have been inserted correctly (see “4.1. Removing the battery insulation strips, replacing the batteries” on page 14).
Test strip inserted incorrectly or not completely.	Firmly insert the test strip into the slot on the device with the contacts first. Make sure that the front of the test strip is facing you (see “Test strip” on page 13).
Device faulty.	Contact Customer Services.

Problem: the test does not start after inserting the test strip into the device and applying blood.

Cause	Solution
Insufficient blood or test strip not filled correctly.	Repeat test using a new test strip and a larger drop of blood.
Faulty test strip.	Repeat the test using a new test strip.
Blood was applied while the device was switched off.	Repeat the test using a new test strip and only apply blood when  flashes.
The basic settings of the device have been changed and these changes were not completed (see “4.2 Making and changing basic settings” on page 15).	Remove the test strip and press the ON/OFF button until “OFF” is displayed. Repeat test.
Device faulty.	Contact Customer Services.

9 TECHNICAL SPECIFICATIONS

Dimensions (L x W x H)	123 x 28 x 16 mm
Weight	36g (incl. batteries)
Power supply	2 x 3 V CR 2032 button cell batteries
Battery life	Over 1000 measurements
Measured value memory	480 measured values with date/time Data retained when batteries are changed
Average values	for 7, 14, 30, 90 days
Automatic switch-off	Two minutes after last actuation
Storage/ transport temperature	Temperature: +2°C – +30°C Relative humidity: < 90%
Operating ranges	Temperature: +10°C – +40°C Relative humidity: < 90% non-condensing
Measuring range, glucose	Glucose: 20–630 mg/dL
Blood sample	capillary whole blood
Required volume of blood	0.6 microlitres
Blood glucose measuring duration	Approx. 5 seconds
Calibration	Plasma
Test procedure	Amperometric bio sensor
Usage	Suitable for self-testing
System function test	Each time device is switched on

EMC

This device complies with the European standard EN 61326 and is subject to specific precautions with regard to electromagnetic compatibility. Please note that portable and mobile HF communication systems may interfere with this unit. For more details, please contact Customer Services at the address indicated.

Test strip functionality

Test strips enable a quantitative measurement of the glucose level in fresh whole blood. When the gap for taking blood comes into contact with a drop of blood, it is automatically filled by simple capillary action. The blood is sucked into the absorbing gap on the test strip and the blood glucose monitor measures the blood glucose level in the blood.

The test is based on the measurement of an electric current that is generated by the chemical reaction of the glucose with the enzyme glucose dehydrogenase (*Aspergillus* sp.) on the strip.

During the reaction, a mediator transports electrons through the electrode surface and so generates a current.

The blood glucose monitor analyses this current. The current flow is proportional to the glucose content in the blood sample. The results are shown on the blood glucose monitor display.

Only a small amount of blood is required (0.6 microlitres) and measurement takes approx. five seconds. The test strip detects blood glucose values from 20 to 630 mg/dL.

Chemical components of the test strip sensor

- FAD glucose dehydrogenase 6%
- Potassium ferricyanide 56%
- Non-reactive components 38%

Control solution functionality

The control solution contains a fixed amount of glucose that reacts with the test strip. A test with control solution is similar to a blood test. However, control solution is used instead of blood. The measured result using control solution must be within the result range. This range is printed on each test strip box.

Chemical composition of the control solution

The control solution is a red solution with the following D-glucose level (in percentage shares):

Ingredients	Control solution LEVEL 3	Control solution LEVEL 4
D-glucose	0.14%	0.37%
Non-reactive components	99.86%	99.63%

Standards

The Beurer GL50 blood glucose monitor complies with the European standards: IVD (98/79/EC) and MDD (93/42/EC).

Comparison of measured values with laboratory values

Performance characteristics: accuracy and precision

Whole blood glucose test results were compared with the YSI 2300 laboratory device. At a concentration of $<75 \text{ mg/dL}$ $\geq 98\%$ were at $\pm 15 \text{ mg/dL}$, while at a glucose concentration of $\geq 75 \text{ mg/dL}$ $\geq 98\%$ were within 20% of the reference values. The CV (coefficient of variation) is $< 5\%$. The blood glucose monitor is therefore comparable to a laboratory system.

You will find further details and information regarding blood glucose results and various technologies in general medical literature on the subject.

Usage limits for specialist personnel from the healthcare sector:

1. If the patient exhibits the following symptoms, it may be the case that no correct values can be obtained:
 - Acute dehydration
 - Acute hypotension (low blood pressure)
 - Shock
 - Hyperosmolar hyperglycaemic condition (with or without ketosis)
2. Lipaemic samples: cholesterol levels up to 500 mg/dL and triglycerid levels up to 1,000 mg/dL do not influence the results. Severely lipaemic blood samples were not tested with the Beurer GL50 monitor; therefore, using the device with these samples is not recommended.
3. Blood glucose monitors designed for home use should not be used for severely ill patients.
4. The effect of interfering substances on the measurements depends on the concentration in the blood. The maximum concentrations of certain substances listed below do not significantly influence the measurements.

Influence	Blood glucose value			
	80 mg/dL	120 mg/dL	500 mg/dL	
Concentration of tested substances				
Ascorbic acid	4.0 mg/dL	10.9%	-1.8%	4.6%
Ibuprofen	50.0 mg/dL	3.1%	2.9%	4.6%
L-dopa	1.8 mg/dL	10.6%	7.9%	4.9%
Sodium salicylate	50.0 mg/dL	-2.6%	9.4%	-0.8%
Tetracyclin	1.5 mg/dL	-5.3%	3.8%	3.2%
Tolbutamide	100.0 mg/dL	-2.6%	12.3%	0.9%
Unconjugated bilirubin	2.4 mg/dL	-2.5%	4.1%	-0.2%
Uric acid	8.0 mg/dL	2.7%	9.6%	-1.8%
Xylose	4.0 mg/dL	7.6%	0.8%	7.5%

10 GUARANTEE AND CUSTOMER SERVICE

Warranty

We offer a 3-year product warranty against material and production faults.

The warranty does not cover:

- Damage due to improper operation
- Wearing parts
- Deficiencies already known to the customer upon purchase
- Cases of personal negligence on the part of the customer
- Outside interference

The warranty does not affect the customer's statutory rights. To assert a warranty claim within the warranty period, the customer must provide proof of purchase. The warranty claim must be submitted within a period of 3 years from the date of purchase to BEURER GmbH, Söflinger Straße 218, D-89077 Ulm (Germany). In the event of a warranty claim, the customer reserves the right to have the goods repaired at our own workshop or at a workshop authorised by us. No further rights are granted to the customer (on the basis of the warranty).

Customer service address

Please contact our customer service if you have any questions: Please refer to the address list enclosed for our customer service address.

OUR COMMITMENT TO YOU: We aim to satisfy you by providing high-quality medical products and the best customer service. Please contact our customer service if you are not entirely satisfied with the product.

