

# Blood Pressure Monitor

## BPBIO 320 Quick Installation Guide

### Contents of the Box

Make sure all of the following items are included in the box.

#### A. Included Items

- 1 BPBIO320
- 2 User's Manual
- 3 Power Cord (AC 250V 10A 1.8m) 1EA
- 4 Guide panel
- 5 Cuff 2EA (One of them is already installed.)
- 6 2 Rolls of Thermal Printer Paper
- 7 Screws 2EA

#### Optional

- 8 2EARS-232C Serial Cable
- 9 Blood Pressure Monitor Desk (Blood Pressure Monitor Desk is sold separately.)

#### B. Requirements

- (1) Indoor use only. Any outdoor area where the equipment is to be located should meet all the conditions below.
- (2) Operation environment: 10 ~ 40 °C (50 ~ 104 °F), 30 ~ 75% RH
- (3) Optimum pressure: 70 ~ 106kPa
- (4) Power supply: AC 100-120/200-240V, 50/60Hz

### Exterior & Functions

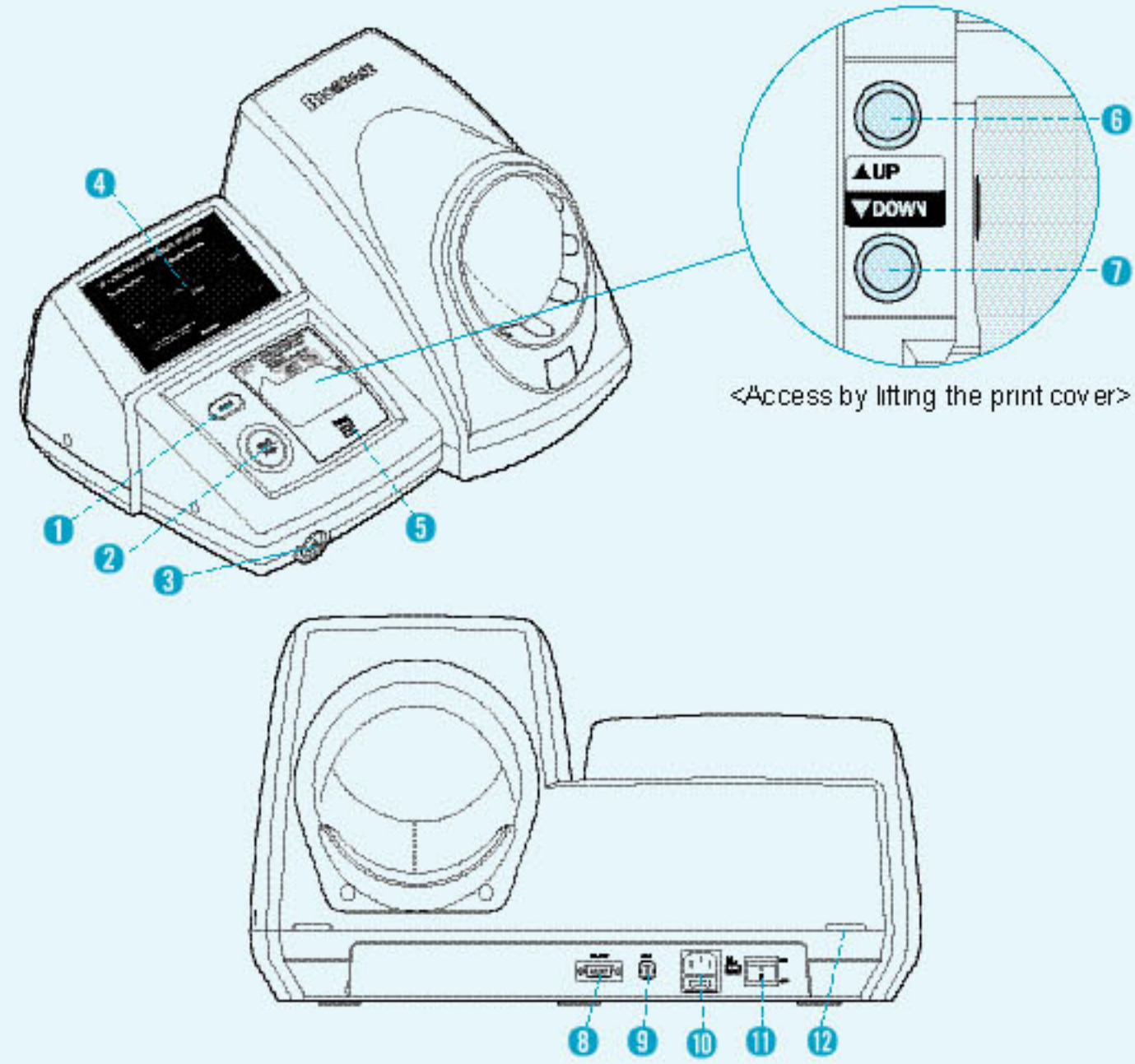

- 1 **Print** : Test results print button
- 2 **Start/Stop** : Test start/stop button
- 3 **Emergency** : Emergency termination button
- 4 **Test results and time indicator**
- 5 **Printer paper cover**
- 6 **7** : Set-Up button for setting up
- 8 **Port for communication with other devices**
- 9 **Terminal for connecting devices such as mercury sphygmomanometer to adjust pressure gauges**
- 10 **Input terminal for outer 220V power**
- 11 **Switch to turn the equipment On/Off**
- 12 **A furrow to fixate equipment to table in order to prevent theft**

### Installation

- (1) Place the BPBIO320 on a sturdy table.  
If you purchased the blood pressure monitor desk, place the bottom of the equipment on the desk furrow, and use the screws (2EA) to fixate the equipment to the desk.

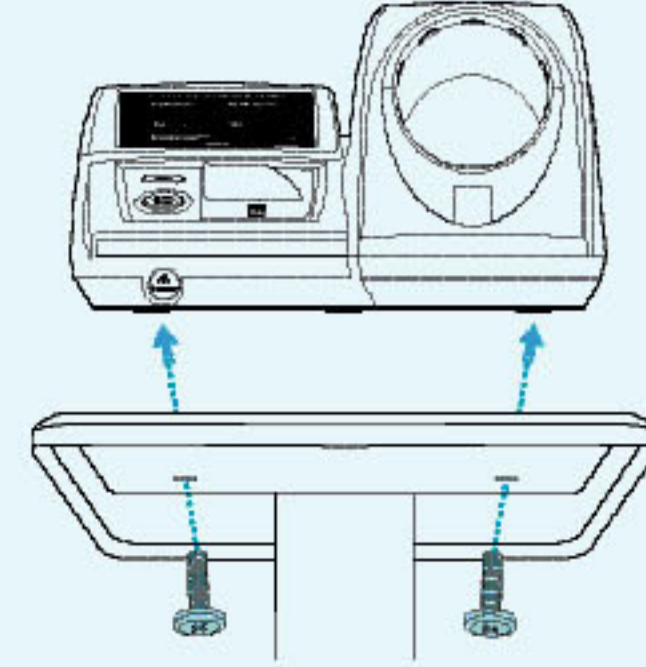

Blood pressure monitor desk is sold separately.

- (2) Connect the power cord into the 10 power socket.

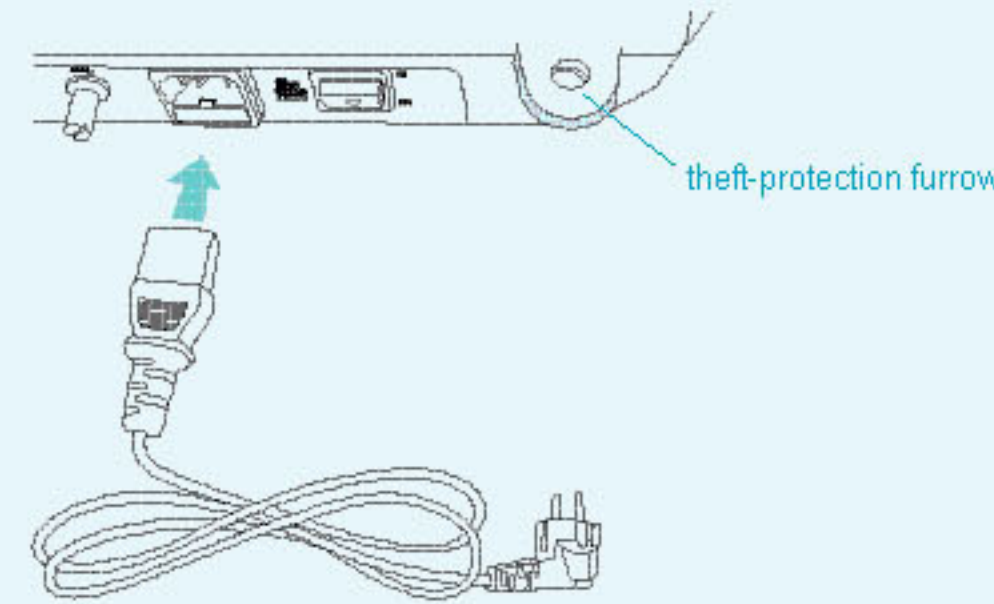

You can fixate the equipment by using the theft-protection furrow.

- (3) Adjust the height of the chair so that the examinee's arm rests in the level as high as to his/her heart.

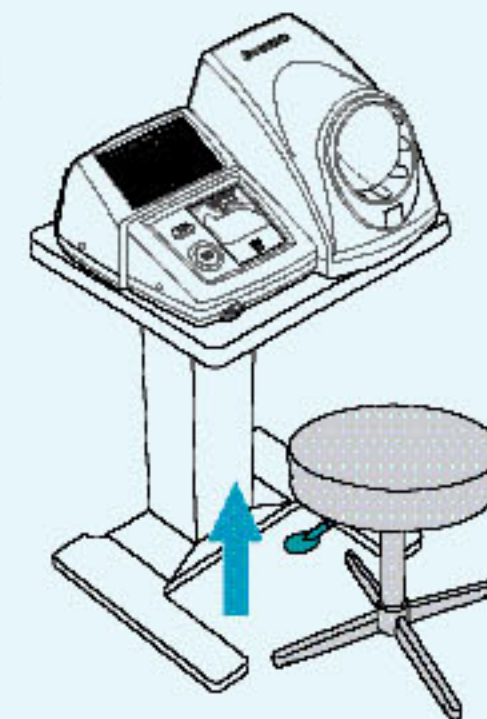

Use only the power cord provided by Biospace.

Always be careful when handling the equipment. External shock will cause problems with the equipment's performance.

Keep the original packing material with you after installation in the event of relocation.

### Cautions during Measurement

#### A. The following might cause the blood pressure test results to be inaccurate.

- (1) Psychological stress, anxiety, or excitement
- (2) Exercise or sauna
- (3) Drinking alcoholic beverages or coffee, smoking, or drug intake
- (4) If you suffer from illnesses such as diarrhea or the cold.
- (5) The need to go to the bathroom before of during exam.

#### B. Please take notice of the following when you are taking your blood pressure.

- (1) If you find any abnormalities with the equipment, stop the equipment immediately, and take safety measures. Request an inspection from the manufacturer.
- (2) Do not use in a place highly humid or wet.
- (3) Do not use on newborns.
- (4) Take your blood pressure at least 1~2 hours after a meal.
- (5) Do not take your blood pressure for a long period of time continuously.

### Blood Pressure measurements

1. Turn on the power switch. Carrying out the self-calibration during turn on the equipment. Do not touch the equipment when do self-calibration.

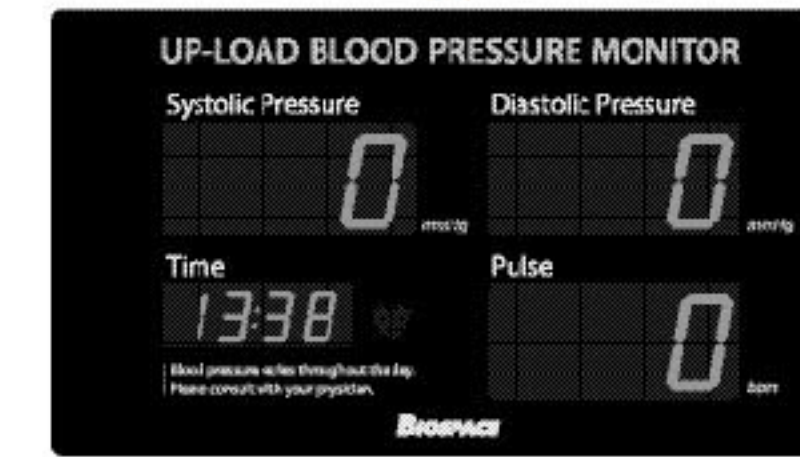
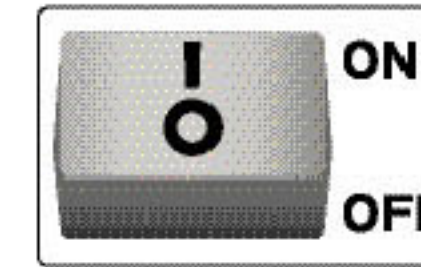

2. Pull chair forward and sit up straight. Avoid wearing a thick jacket, coat, or sweater. Put your legs gently underneath the desk.

There might be an error in the test if you are wearing thick clothing.

3. Insert your arm all the way into the opening and make sure that your elbow rests on the band. Adjust the seat so that the weight of your arm in the cuff is parallel with your heart.

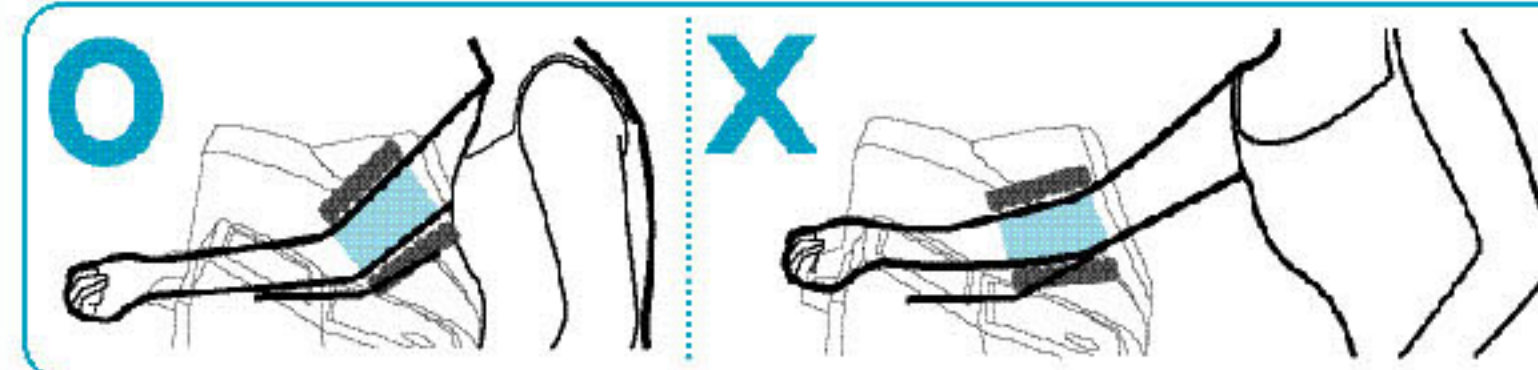
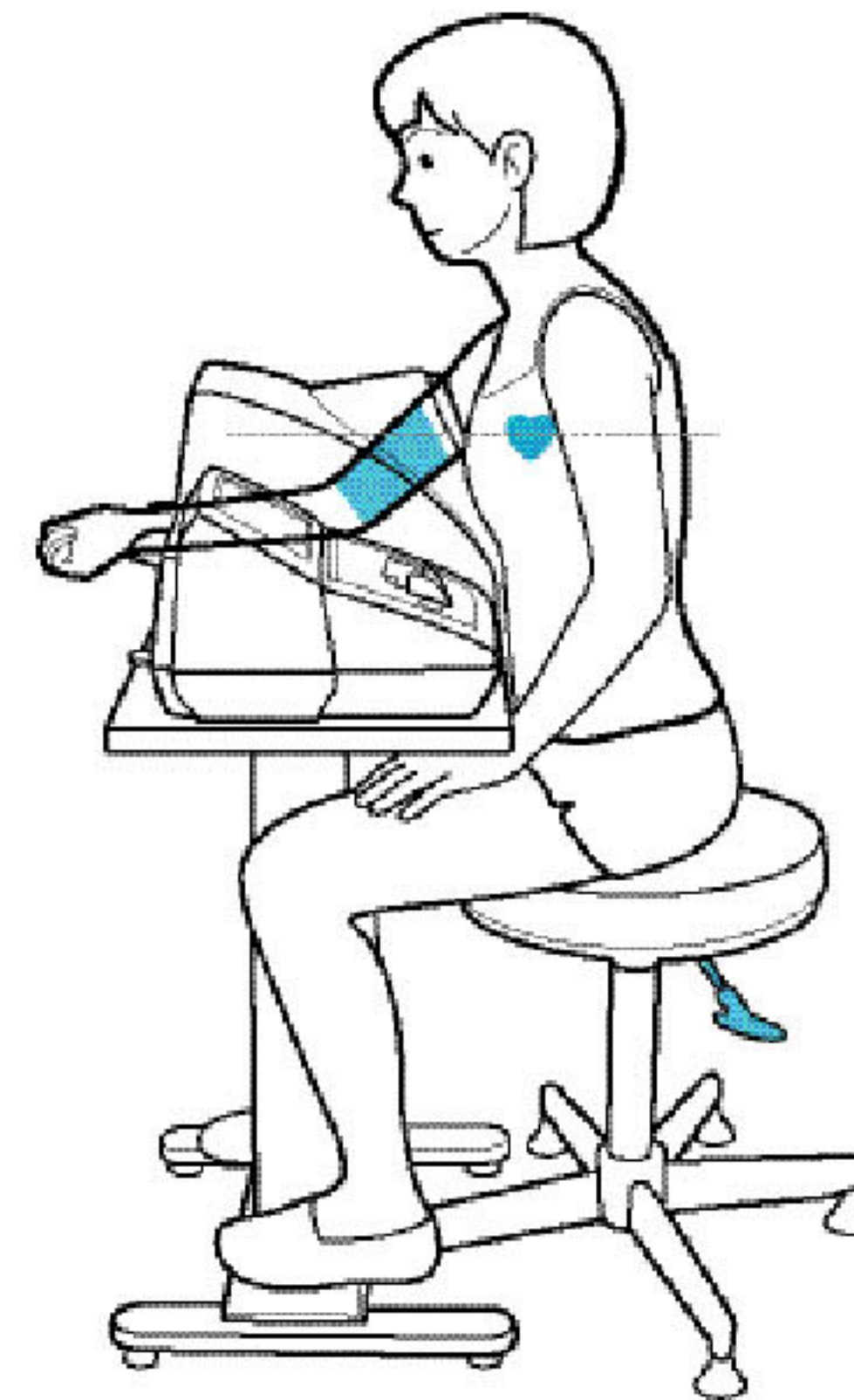

4. Place your arm in the blood pressure cuff and relax.

Make sure that you have fully inserted your arm into the cuff.

5. Press the **Start/Stop** button to start the test. Do not move your body during measurement for accurate test results.

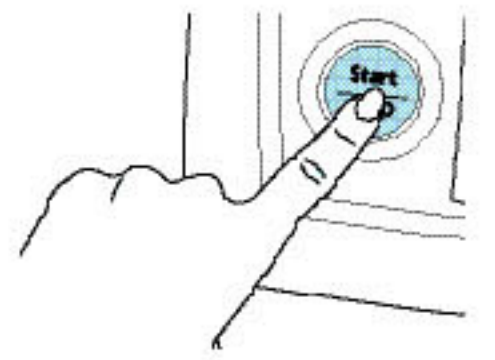

If there is an emergency during the testing procedure, press the **Emergency** button in the lower-left corner of the front part of the device. The machine will automatically stop and the cuff will loosen. If the air in the cuff does not deflate after you press the **Start/Stop** button, please turn off the equipment.

6. The cuff will automatically add pressure, and will slowly inflate and take your blood pressure.

7. Relax and stay still for a few minutes.

8. Once measurement is completed, the cuff will automatically loosen. Pull arm out when cuff is fully loosened.

9. The BPBIO320 prints out the test results sheet. Printed paper will cut automatically. Do not pull paper while printing. After printing, pull the paper to the right side.

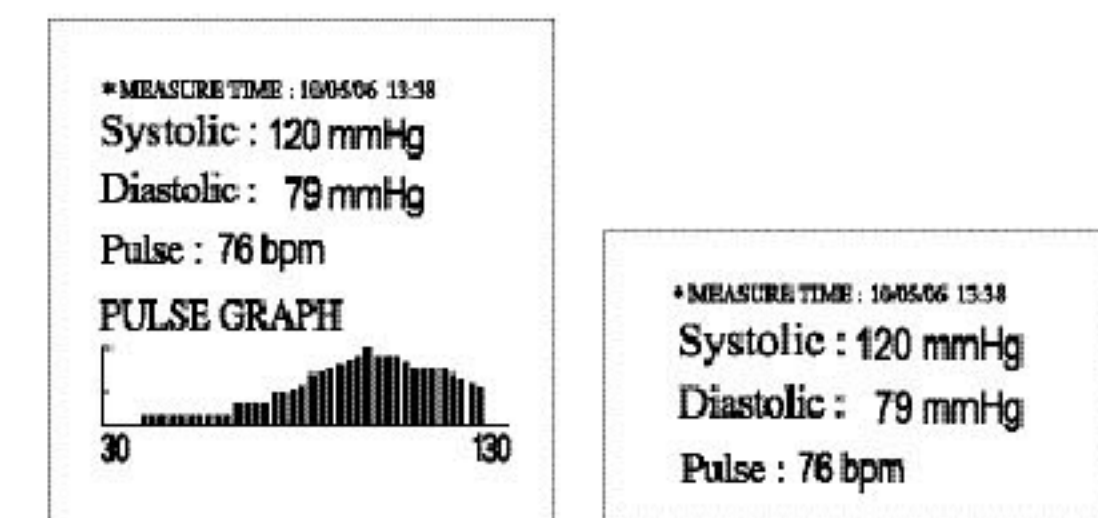

Please refer to the back page for specific instructions on changing equipment settings.

To re-measure your blood pressure, you may do so after at least a 5 minute resting period.

Your blood pressure can change in different environments. Please consult a physician for test result's accurate diagnosis.

### BIOSPACE

©1996-2010 Biospace Co., Ltd. All rights reserved.

#### Notice

This user's manual cannot be copied, translated or transformed into different media without a prior written consent from Biospace Co., Ltd, according to the copyright laws. This user's manual and product pertinent to this manual may have misprints or technical flaws, which can be modified without prior notice to the readers. Biospace is not liable for any damage caused by a failure to meet the requirements in this user's manual.

#### Biospace Co., Ltd.

518-10 Dogok 2-dong, Gangnam-gu, Seoul 135-854 KOREA  
TEL : 82-2-501-3939 FAX : 82-2-501-3978

Homepage : <http://www.e-InBody.co.kr> E-mail : [info@biospace.co.kr](mailto:info@biospace.co.kr)

Biospace reserves the right to modify the dimensions or exterior of BPBIO320 to improve the quality of the products, without consent of the customer.



## Setup

The BPBIO320 has a function to modify the setting according to user preference. The setup menu consists of audio setup, audio volume, time & date, self-assessment, print results sheet and print caution message.

### A. How to modify settings

- (1) If you press the **Menu** button with the **Enter** button simultaneously in the home screen for 2 seconds, you will see the following page.



- (2) Press the **Menu** button to change the equipment settings to your preference.

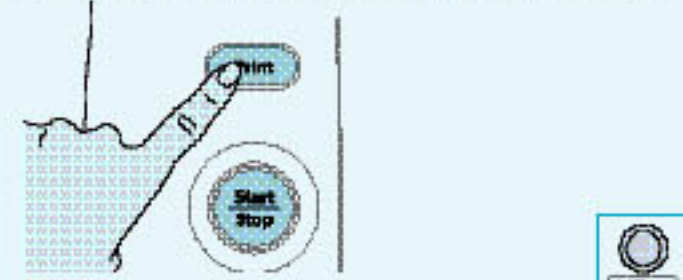

- (3) Use the UP(▲) DOWN(▼) buttons to change specific settings.
- (4) Changes made in the settings will be saved automatically.
- (5) After you have finished changing the equipment settings, press the **Menu** button for 2 seconds.
- (6) The screen will return to the home screen.

When changing your settings, press the **Menu** button for 2 seconds to return to the home screen.

※ The following is an example on how to change your settings if you don't want to hear any sound.

- 1 Press the **Menu** button with the **Enter** button simultaneously in the home screen for 2 seconds.
- 2 Press the **Menu** button to move to the screen where you can see **5nd SEL** the screen.
- 3 Press the **Down** button to choose **NON**.
- 4 Press the **Menu** button for 2 seconds to save the settings and return to the home screen.



### B. Functions

The following are phrases that will appear on the screen. (Systolic pressure/Diastolic pressure/Pulse) Please refer to the following when changing the examinee's settings.

Function	Screen			Explain
	Systolic	Diastolic	Pulse	
Audio setup	5nd	SEL	bEF	Alarm sound
			NON	No sound
Audio volume	UDL	0-160		0~160 adjust volume
Time / Date	CLD		HOU	Lower-left Time display blinks, can change settings
			NUt	Lower-left Time display blinks, can change settings
			YEa	Set up year (00~99 possible)
			MEh	Set up month (00~99 possible)
			DAY	Set up day (00~99 possible)
Self-assessment	SEF			Press the <b>Enter</b> button to start self-assessment. If an error is detected, a message will be printed. It returns to the home screen after self-assessment.
Print results sheet	Pri	nt	dat	Express print Time, Systolic, Diastolic, Pulse
			grP	Graphs print Time, Systolic, Diastolic, Pulse, Pulse Graph
			OFF	Cannot print results sheet.
Print Caution message	320		8	Caution message will be printed.
			5	Caution message will NOT be printed.

## Cuff Cover Replacement

- 1 Open the cover as illustrated in the picture, and unscrew with a screwdriver.
- 2 Unscrew the two screws in the back using a screwdriver.
- 3 Remove the front/back rings, and pull on the cuff cover to disassemble.
- 4 Place the new cuff cover as illustrated in the picture.
- 5 Fixate the new cuff cover in the front/back cover.
- 6 Reassemble the disassembled front/back rings, and screw tightly.
- 7 Close the cover.

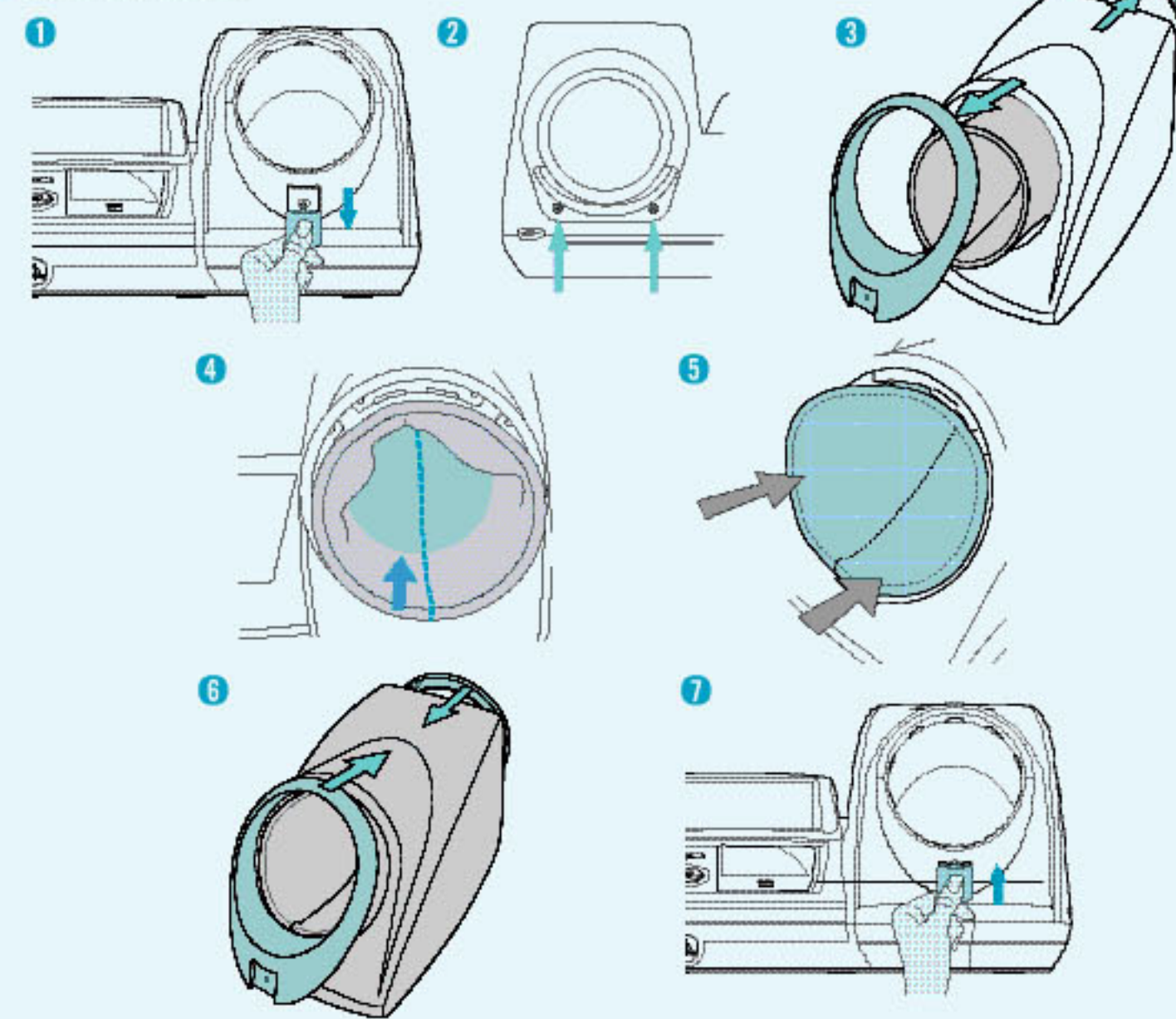

Make sure the cuff cover's dotted line is facing downwards. If the cuff cover is on upside-down, it could affect the testing results.

Cuff is sold separately. Cuff is consumable.

## Printer Paper Settings and Replacement

### A. Printer Paper Installation

- (1) Cut the end of the printer paper with scissors. If the end is not smooth, the paper might jam in the printer or may cause damage to the printer head.
- (2) Make sure the power is on, and press on the center of the bottom of the printer cover to open.
- (3) Place the printer paper as illustrated in the picture.

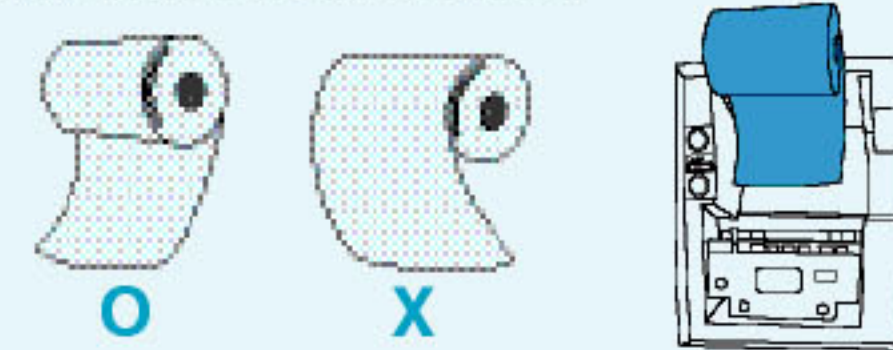

- (4) Insert the paper into the horizontal slot on the bottom. The paper will come out the arrow pointed direction and will automatically cut.

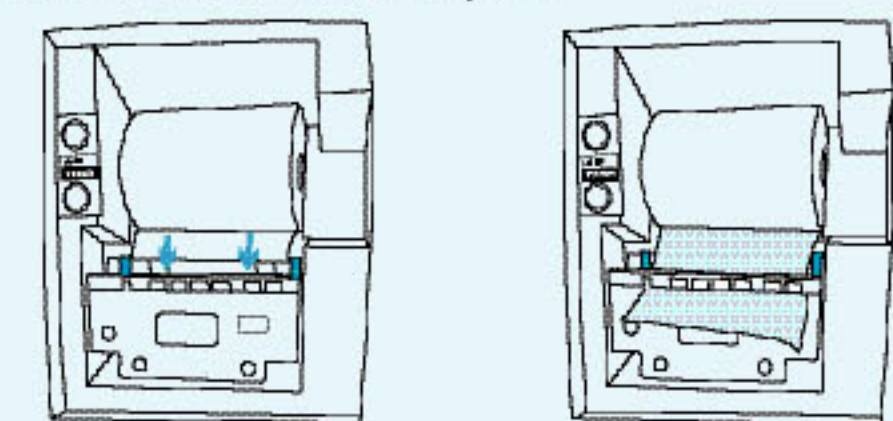

- (5) Remove the paper that has been cut automatically and close the printer cover.

### B. Printer Paper Replacement

- (1) Press on the center of the bottom of the printer cover to open. (Make sure the printer is on.)
- (2) Before replacing the printer paper, press on the **Enter** button until the printer paper has come out.
- (3) Replace the new printer paper following the 'A. Printer Paper Installation'.

## Changing Fuses

- (1) The fuse socket is located at the bottom of the back of the BPBIO320.

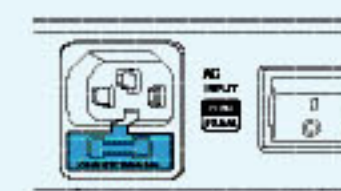

- (2) Use the fuse socket furrow to remove the fuse. Replace with extra fuses or purchase additional fuses.

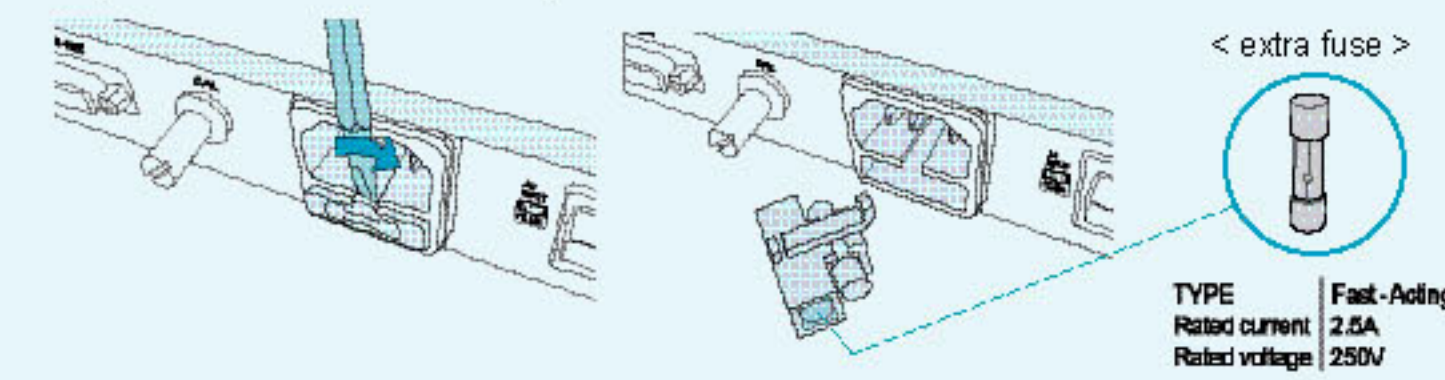

Turn off the equipment, when changing fuses.

## Problems and Solutions

### Before you think the equipment is broken

This section lays out the order of steps you have to take in case of malfunction, with the assumption that you have some basic knowledge about how to operate the equipment. If you still have the problem after taking the following steps, contact the local distributor or Biospace.

- (1) Nothing appears on the screen even when I turn on the equipment.

**Cause 1** The plug is not pushed all the way into the electrical outlet.  
**Action 1** Push the plug all the way into the electrical outlet.

**Cause 2** Fuse blows.  
**Action 2** Replace with a new fuse.

TYPE  
Rated current 2.5A  
Fast-Acting  
Rated voltage 250V

- (2) The analysis results are unexpected or unusual.

**Cause 1** Examinee's inappropriate posture may cause errors.  
**Action 1** Make sure the examinee's arm is at his/her heart level. You should make sure that the examinee does not speak or move and maintains his/her posture.

**Cause 2** If you are wearing thick clothing, the test results might be inaccurate.  
**Action 2** Remove your clothing and try again. The equipment uses your heart rate to make measurements. If your heart rate is weak or irregular, it is hard to produce accurate measurements.

- (3) Cannot print results sheet.

**Cause 1** The results sheet setting is inappropriate.  
**Action 1** Check the printer settings of the BPBIO320. If the 'Print results sheet' setting is set to **OFF**, it will not print the results sheet.

**Cause 2** If you used up all your results printer paper.  
**Action 2** Printer paper is consumable, and the replacement period will differ depending on how much you use your printer. If you have used up all your printer paper, press on the center of the bottom of the printer cover to open the printer and replace printer papers. Please refer to 'Printer Paper Settings and Replacement' on how to replace your printer paper.

Repair and examination should be conducted only by Biospace's professional A/S staff. Please contact Biospace if needed. As error message and the misprints are something that technical service representatives can examine in the process of troubleshooting, so keep them in a safe spot or keep records of them.

## Maintenance

1. Do not move or relocate the BPBIO320 while the power is on.
2. Do not drop any food or liquid on the equipment. It may affect the electrical parts in the equipment or cause damage.
3. Once a week, wipe the exterior sides of the BPBIO320 with a dry towel. In particular, clean the LCD monitor, using gentle care not to scratch the surface.
4. Please replace your cuff cover when it gets dirty or is worn down.
5. Follow local governing ordinances and recycling plans regarding the disposal or recycling of device components.

## Safety Information

1. In order to prevent electrical shock, please use the Three Pole Socket as illustrated in the picture.
2. Use rated fuse that has rated current and voltage.
3. Do not immerse the power cord in water.
4. Do not dismantle the equipment or open the back cover. Internal parts are not for customer use. If the equipment is dismantled, the warranty is void, and service costs will be charged. If service is required, contact Biospace or the supplying agency.
5. The test results can only be interpreted by an experienced physician, and the equipment cannot be used for assessment or administration solely by a consumer without the consultation of a physician. Please consult with your physician.
6. Do not touch signal input, signal output or other connectors, and the patient simultaneously.



7. External equipment intended for connection to signal input, signal output or other connectors, shall comply with relevant IEC Standard (e.g., IEC60950 for IT equipment and IEC60601-1 series for medical electrical equipment). In addition, all such combination-system shall comply with the standard IEC60601-1 and/or IEC60601-1-1 harmonized national standard or the combination. If, in doubt, contact qualified technician or your local representative.



1. Excessively high or low temperatures, humidity and pressure might affect on the equipment's operation and cause an error. Please use the machine within the suggested specification range for machine's use.
2. Do not touch the ports on the back side of the BPBIO320.
3. Follow local governing ordinances and recycling plans regarding the disposal or recycling of device components.
4. Be careful not to spill or drop any residues of food or beverages on this equipment. It may cause serious damage to the electronic components.
5. Repair and examination should be conducted only by Biospace's professional A/S staff. Please contact Biospace if needed.



1. The BPBIO320 has been designed, manufactured, and inspected under the full quality assurance system of Biospace. Biospace fulfills the international standardization system, ISO 9001 and ISO 13485.
2. BPBIO320 is a medical device.
3. This equipment has been tested and found to comply with the limits for medical devices in IEC/EN 60601-1-2:1994. These limits are designed to provide reasonable protection against harmful interference in a typical medical installation. This generates, uses and can radiate radio frequency energy and, if not installed and used in accordance with the instructions, may cause harmful interference to other devices in the vicinity. However, there is no guarantee that interference will not occur in a particular installation. If this equipment does cause harmful interference to other devices, which can be determined by turning the equipment off and on, the user is encouraged to try to correct the interference by one or more of the following measures:
  - Reorient or relocate the receiving device.
  - Increase the separation between the equipment.
  - Connect the equipment into an outlet on a circuit different from that to which the other device(s) are connected.
  - Consult the manufacturer or field service technician for help.

## Appendix

### Classification

This product received classification in the following  
Type of protection against electric shock : Class I equipment  
Degree of protection against electric shock : Not classified - Type BF applied parts  
Classification according to the degree of protection against ingress of water as detailed in the current edition of IEC 60529: IPX0, ordinary equipment.  
This equipment is not suitable for use in the presence of flammable anesthetics or oxygen Mode of operation : continuous operation.

### European Standard

EN 1060-1:1995 + A1:2002  
Non-invasive sphygmomanometers Part 1: General requirements  
EN 1060-3:1997 +A1: 2005  
Non-invasive sphygmomanometers Part 3: Supplementary requirements for electro-mechanical blood pressure measuring systems

## Specifications

Measurement Method	Oscillometric
Measurement Range	0~300mmHg(Pressure), 30~200 bpm(Pulse)
Accuracy	± 3mmHg (Pressure), ±5%(Pulse)
Measurement Result	Systolic & Diastolic Blood Pressure, Pulse
Measurement Duration	Average 40sec. (30~60sec. depending on the pulse rate or blood pressure)
Type of Results Sheet	Express Print / Graphs Print
Safety Device	-If you press on the Emergency button, the cuff will become loose for deflation. (Dual safety device system that cuff will become loose for deflation regardless of the central controller)
	-If you press on the Start/Stop button, the cuff will become loose for deflation.
	-If the air pressure surpasses 300mmHg, the cuff will automatically deflate and loosen.
Printer	Express thermal printer with automatic cutter
Power Source	AC 100-120/200-240V, 50/60Hz, 70VA
Dimensions	489(W) X 409(L) X 284(H) : mm 19.3(W) X 16.1(L) X 1.2(H) : inch
Weight	9kg(19.8lb.)
Operation Environment	10 ~ 40°C (50 ~ 104°F), 30 ~ 75%RH, 70 ~ 106kPa
Transport and Storage Environment	-20 ~ 50°C (-4 ~ 122°F), 10 ~ 95%RH, 50 ~ 106kPa (No condensation)

※ Specifications are subject to be changed without prior notice.

**BPBIO320**  
THE PROFESSIONAL BLOOD PRESSURE MONITOR