



Confirm

Blood Glucose Monitoring System

User
Instruction
Manual



CAUTION:

Before using any product to test your blood sugar (blood glucose), read all instructions and practice the test. Do all quality control checks as directed and consult with a diabetes healthcare professional. These recommendations apply to all blood glucose monitoring systems and are supported by the American Association of Diabetes Educators, the American Diabetes Association, the U.S. Food and Drug Administration, and the Health Industry Manufacturers Association.

TABLE OF CONTENTS

Introduction	5
Intended Use	6
Understanding the ReliOn® Confirm Blood Glucose Meter	7
Changing the Battery	10
Meter Set-up	13
Basic Rules	13
Audible Beep	16
Year	18
Month/Day	19
Hour/Minute	20
Test Averaging	21
Ending Set-up	22
Performing a Control Solution Test	23
Troubleshooting Control Solution Test	30

Blood Glucose Testing	33
The Lancing Device	33
Getting a Drop of Blood	36
Performing a Blood Glucose Test	38
Flagging Test Results.	42
Alternate Site Testing (AST)	44
Understanding Test Results.	53
Recalling Results - Entering Memory Mode.	58
Maintenance	62
Cleaning	62
Storage and Handling	63
Display Screen and Error Messages	64
Product Information	69
Product Specifications.	69
Warnings, Precautions & Limitations.	70
Warranty	73

INTRODUCTION

Thank you for choosing the ReliOn® Confirm Blood Glucose Monitoring System. This system measures blood glucose in fresh capillary whole blood. Results are shown as plasma values. This makes it easy to compare the ReliOn® Confirm blood glucose meter and lab results.

Please read this manual before using the system. If you have any questions, call Customer Service at 800.631.0076 (24 hours a day, 7 days a week). Contact your healthcare professional with questions if you are unable to reach Customer Service.

Intended Use

The ReliOn® Confirm Blood Glucose Monitoring System meter is intended for the quantitative measurement of glucose in fresh capillary whole blood samples drawn from the fingertips or palm. Testing is done outside the body (*In Vitro* diagnostic use). It is indicated for use at home (over the counter (OTC)) by persons with diabetes, or in clinical settings by healthcare professionals, as an aid to monitor the effectiveness of diabetes control.

The System Includes:

- Meter
- Carrying Case
- User Instruction Manual
- Quick Reference Guide
- Self-testing Logbook
- Lancing Device
- Lancets



Carrying Case

UNDERSTANDING THE ReliOn® Confirm BLOOD GLUCOSE METER

Top

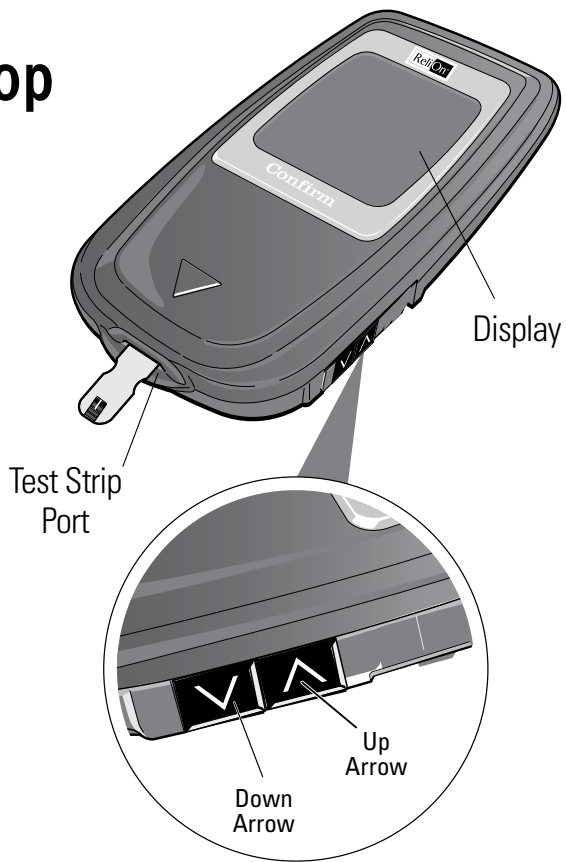

Bottom

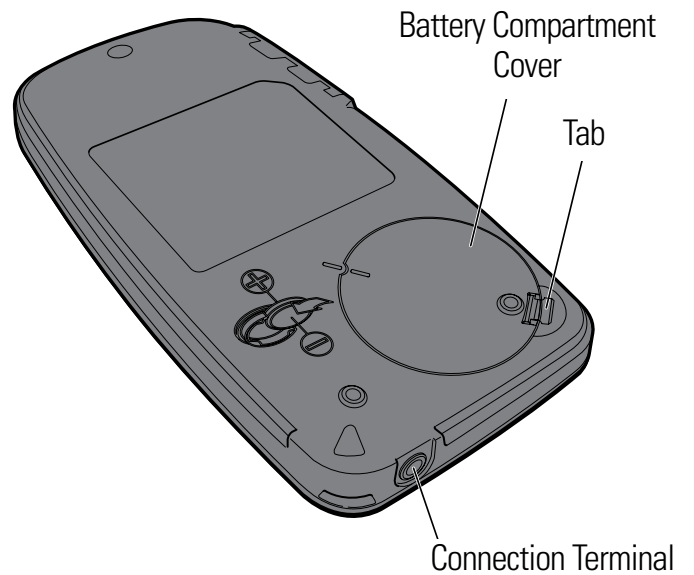

Explanation of the full display screen:

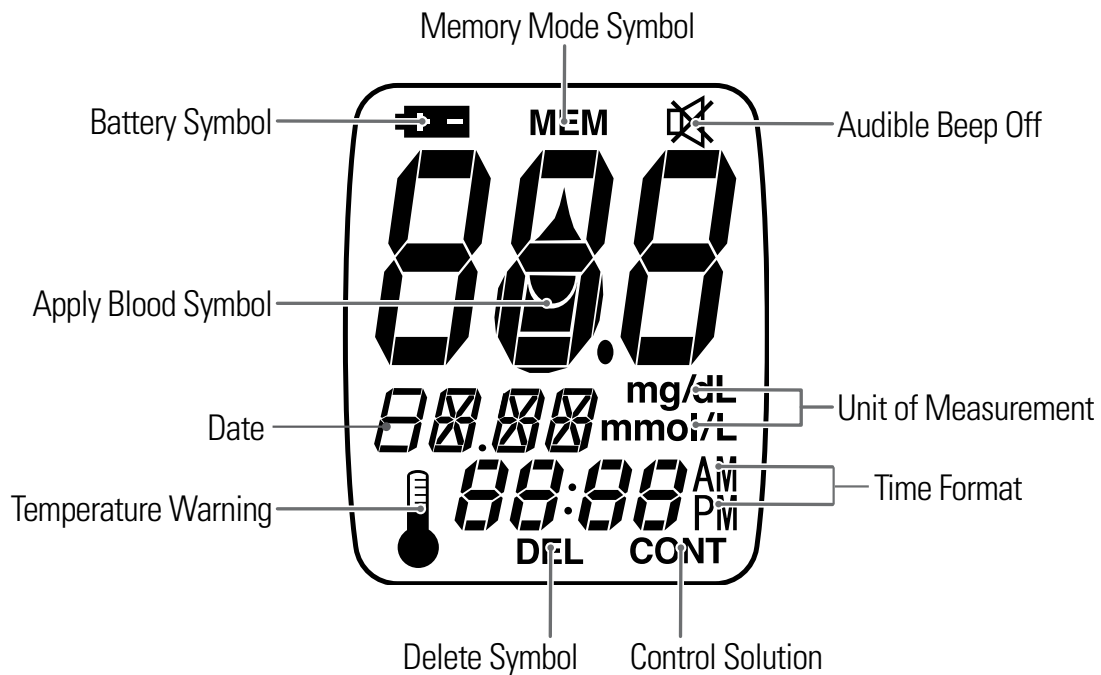

NOTE: Meters in the USA are programmed to show results in mg/dL. Meters used outside the USA are programmed to show results in either mg/dL or mmol/L. Results displayed in mmol/L will always have a decimal point. Results displayed in mg/dL will never have a decimal point.

ReliOn® Confirm/micro test strips

These test strips need only 0.3 µL (microliter) of blood. Apply blood to the sample application tip. The strip draws in the blood by capillary action. The blood glucose reacts with the enzyme on the test strip. This produces a current proportional to the blood glucose level. The meter detects the current and converts it into a blood glucose reading.

Test Strip Bottle

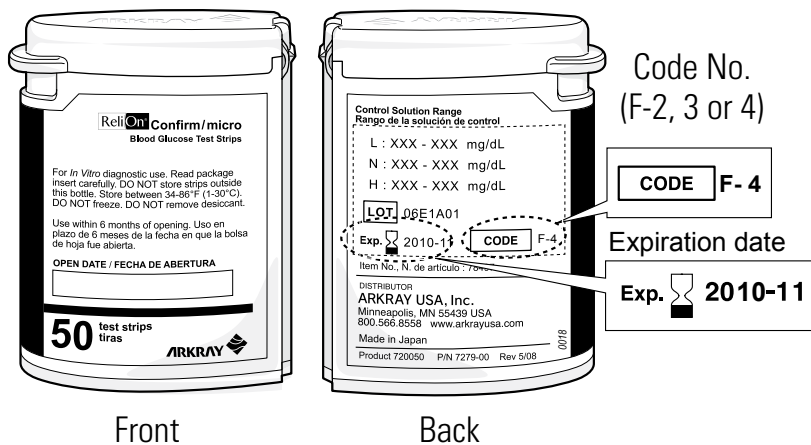

Test Strip

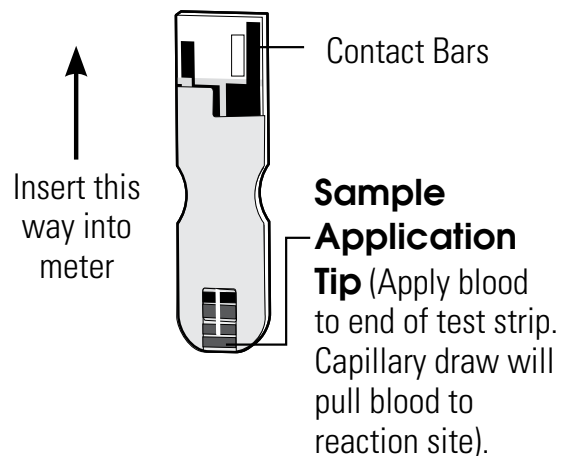

Changing the Battery

The ReliOn® Confirm blood glucose meter comes with one lithium battery CR2032 (or DL2032).

CAUTION: Replacing the battery will not delete meter settings or test results stored in the meter unless you:

- Touch the metal portion on main unit with your fingers or any metal.
- Take over 2 minutes to replace battery.
- Load the battery incorrectly.
- Load a used or weak battery.

NOTE:

- To save battery power, the meter turns itself off 3 – 5 minutes after last use.
- Replace batteries when low battery symbol  appears. Otherwise inaccurate results could be obtained.
- Discard used batteries as per local guidelines.

WARNING: Keep all batteries out of children's reach. If a battery is swallowed, consult a doctor immediately.

To replace battery:

1. Open the battery cover on the back side of the meter by pushing the tab in the direction of the arrow and pulling the cover up.

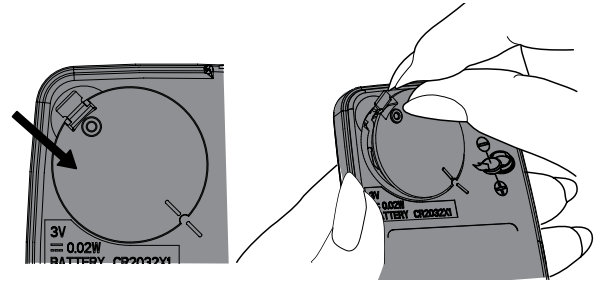

2. The battery is held in place on the underside of the cover. Slide the battery out of the cover.

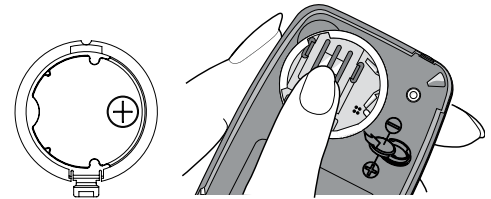

CAUTION: Do not touch the metal contacts inside the battery compartment with your finger or any metal.

3. Load a new battery into the battery cover. Place the "+" side down when loading the battery into the cover.

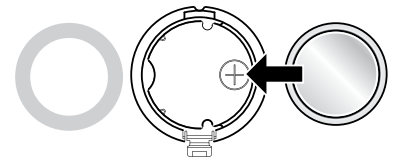

4. Make sure the battery is loaded in the proper position. Otherwise, the preprogrammed times will be reset.

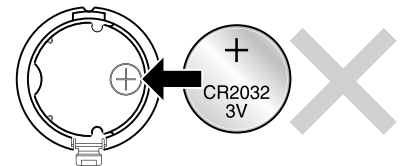

5. Put the battery cover back into correct position and snap to close.

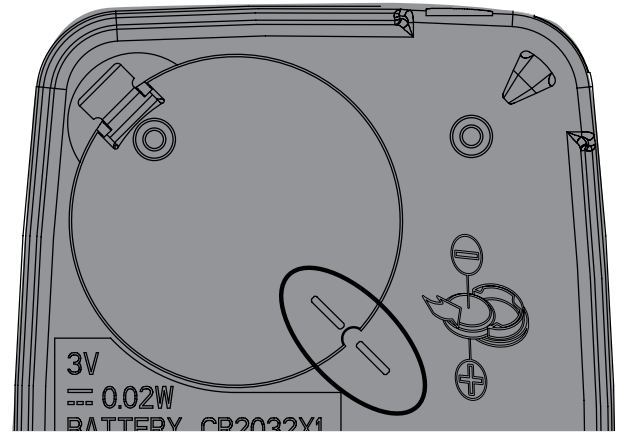
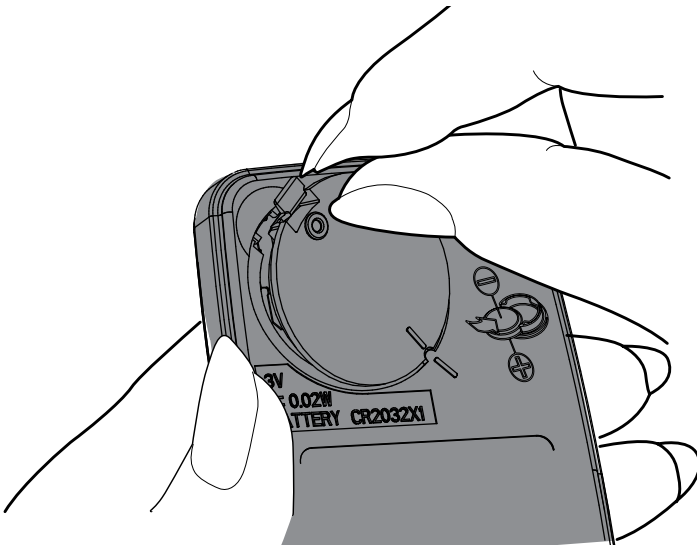

If the clock setting has been deleted, either "12:00" or "0:00" will blink when you put a test strip into the meter. The low battery symbol **+ -** means you need to replace the battery as soon as possible. Discard used batteries as per local guidelines.

METER SET-UP

Before using the ReliOn® Confirm blood glucose meter for the first time, set the time and date. Do not perform a blood glucose test until you have setup the meter.

Meter set-up allows you to adjust the audible beep volume and to set time, date, and test averaging.

Basic rules for meter set-up:

Step 1: Enter meter set-up by first making sure the meter is turned off.

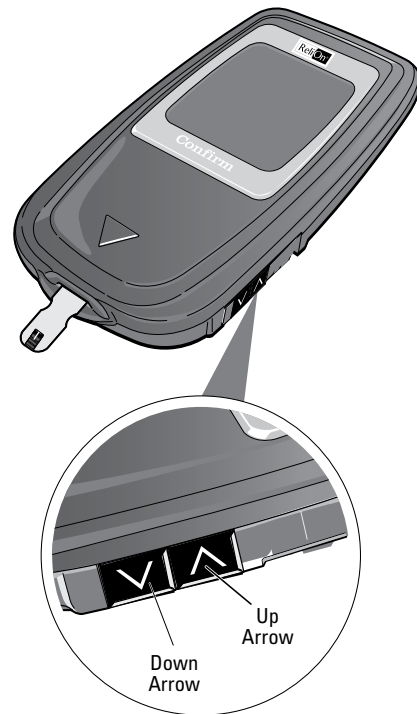

Step 2: Press the Up Arrow and Down Arrow buttons at the same time for 5 seconds. A beep sounds and the meter turns on. Next, a second beep sounds and "SET" shows on the screen.

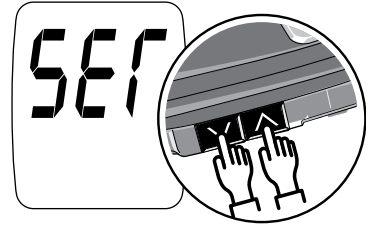

Step 3: Use the Up Arrow to change the set-up screen. When you press the Up Arrow, the set-up screen changes in the order shown in the diagram on the following page. Press the Down Arrow button to change a setting within a set-up screen menu.

Note: If you need to go back to a setting, you must scroll through each set-up option. You cannot go backwards in set-up mode.

In set-up mode, the meter will turn off automatically after 3 minutes of non-use.

Setting the Audible Beep

If the audible beep is turned "on", the beep will sound when:

- You insert a test strip into the meter.
- You apply blood or control solution to a test strip.
- The test has ended and the result is displayed.
- The meter is turned on, but you do not use it for several minutes. Meter will beep and automatically shut off.
- You go into Memory Mode.

Make sure the meter is off. Press the Up Arrow and Down Arrow buttons at the same time for 5 seconds. A beep sounds and the meter turns on. Next, a second beep sounds and "SET" shows on the screen.

Press the Up Arrow button. The screen will display "bUZ" and the current beep setting.

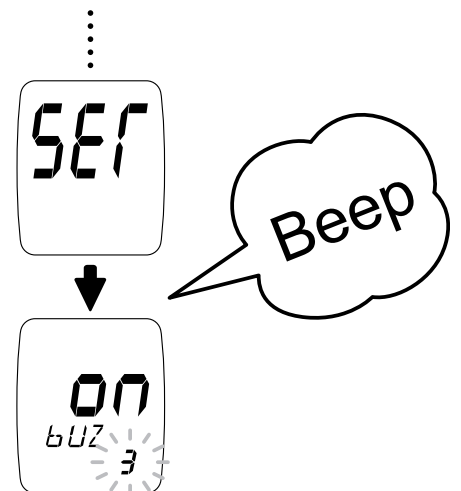

Press the Down Arrow button to cycle through the volume levels:

- "OFF" (no sound)
- "on 1" (low)
- "on 2" (middle)
- "on 3" (high)
- "OFF" (no sound) ..., etc.

A beep sounds at the set volume at each step. If "OFF" is set, the "audible beep mute (Off)" symbol lights up in the upper right of the screen. After you select the beep volume, press the Up Arrow button to confirm the setting. The screen changes to the year set-up screen.

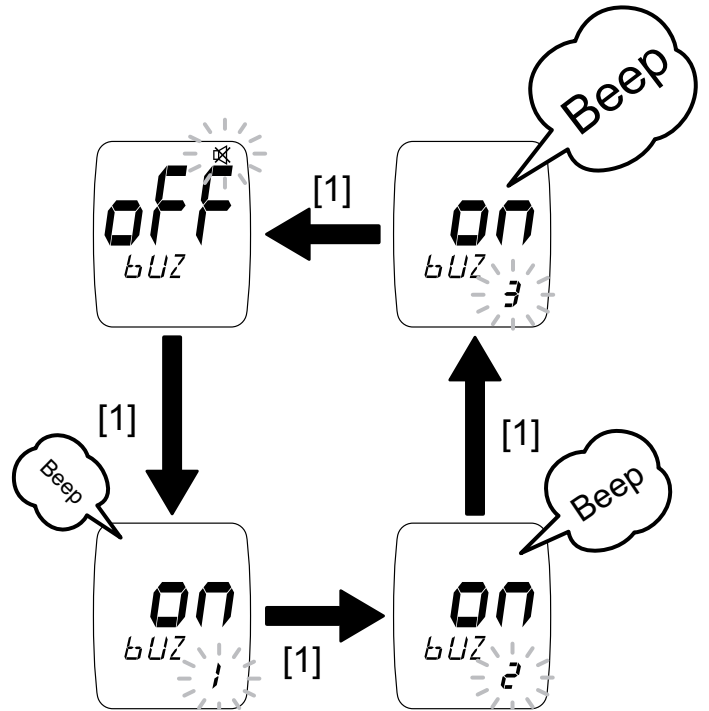

Setting the Year

In the year set-up screen, the last two digits of the currently set year appear at the top of the screen. "yER" appears in the middle of the screen. All four digits of the currently set year appear at the bottom of the screen. The last two digits will blink.

Press the Down Arrow to change the last two digits of the year to the correct year. After you set the year, press the Up Arrow button to confirm the setting. The screen changes to the month set-up screen.

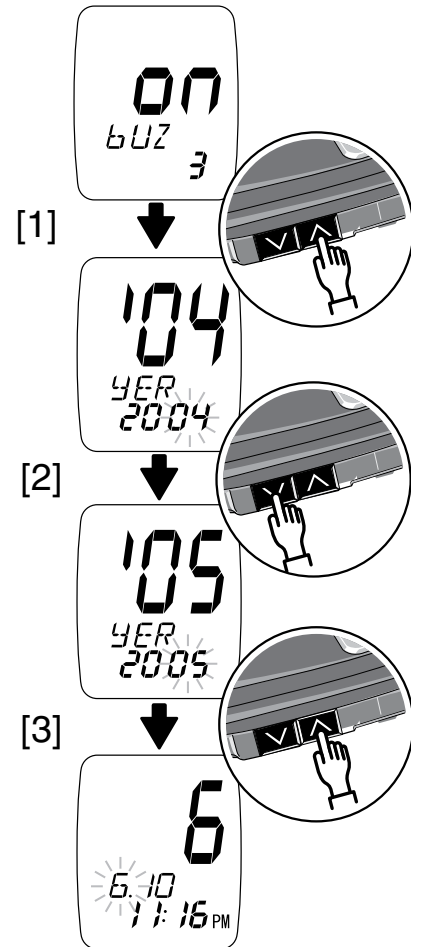

Setting the Month

Press the Down Arrow button to change the month. After you set the month, press the Up Arrow button to confirm the setting. The screen changes to the day set-up screen.

Setting the Day

Press the Down Arrow button to change the day. After you set the day, press the Up Arrow button to confirm the setting. The screen changes to the hour set-up screen.

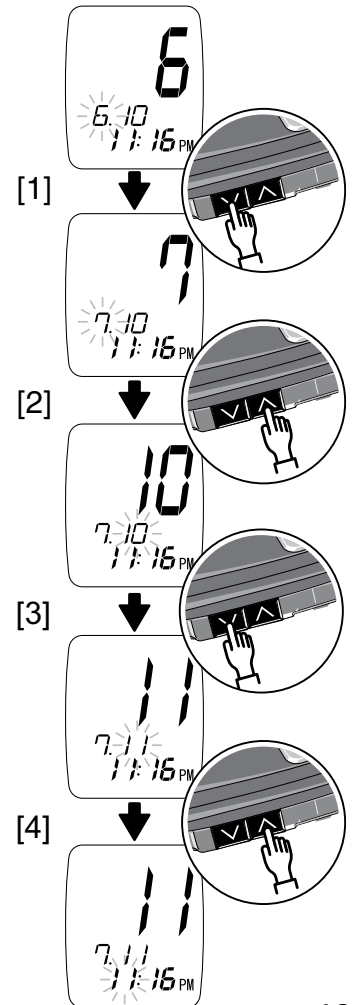

Setting the Hour

Press the Down Arrow button to change the hour. After you set the hour, press the Up Arrow button to confirm the setting. The screen changes to the minute set-up screen.

Setting the Minute

Press the Down Arrow button to change the minute. After you set the minute, press the Up Arrow button to confirm the setting. The screen changes to the test averaging set-up screen.

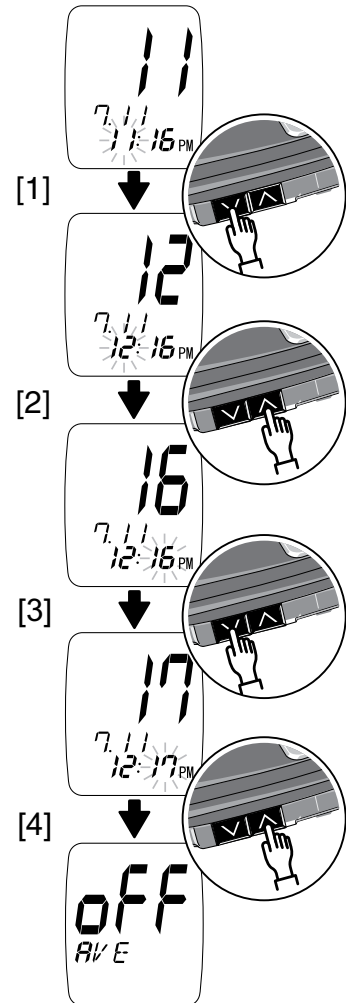

Setting Test Averaging

NOTE: "Lo" results are included as 20 mg/dL in the averages. "Hi" results are included as 600 mg/dL in the averages.

Press the Down Arrow button to cycle through the test averaging choices: "off" (not displayed), "14" (14-day average), or "30" (30-day average). "AVE" appears near the middle of the screen.

If you select either 14-day or 30-day averaging, your average test result will appear when you recall results from memory. See page 58.

After you set test averaging, press the Up Arrow button to confirm the setting.

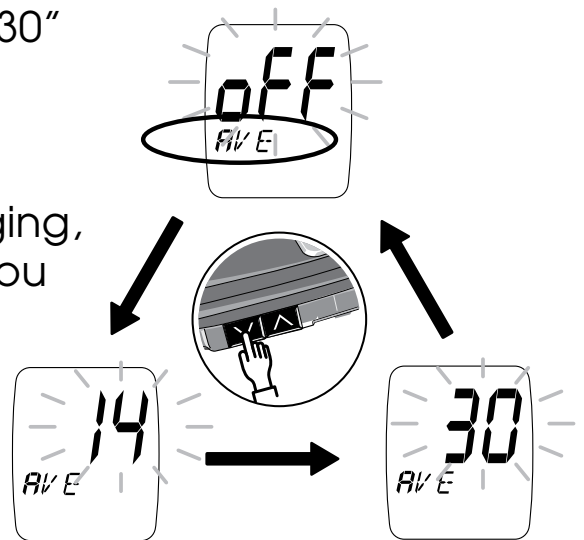

Ending Set-up

To make further changes to set-up settings, press the Down Arrow button while “End” is displayed. This will bring up the Audible Beep set-up screen. You can then move through the set-up mode and adjust any settings that you wish.

If you are done with set-up, press the Up Arrow button while “End” is displayed. This confirms all settings and turns the meter off.

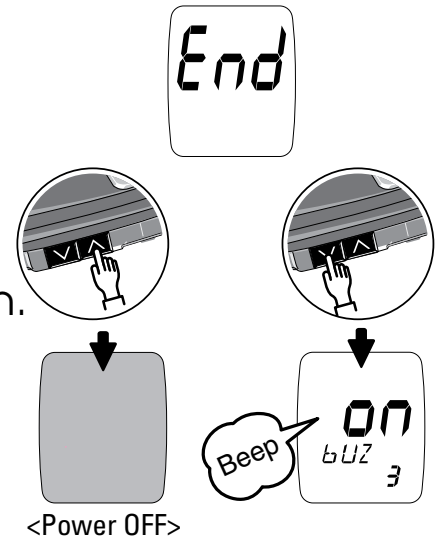

The meter will turn off automatically 3 minutes after “End” is displayed.

PERFORM A CONTROL SOLUTION TEST

Use ReliOn® Confirm/micro CONTROL to check if:

- the meter and test strips are working correctly as a system.
- you are testing correctly.

To order control solution, call ReliOn® at 800.631.0076.

Perform a Control Solution Test:

- Before testing with the ReliOn® Confirm blood glucose meter for the first time.
- Whenever you suspect the meter or test strips may not be functioning properly.
- If test results appear to be abnormally high or low or are not consistent with clinical symptoms.
- The test strip bottle has been left open or has been exposed to temperatures below 34°F (1°C) or above 86°F (30°C), or humidity levels above 80%.
- To check your technique.
- When the ReliOn® Confirm blood glucose meter has been dropped or stored below 32°F (0°C) or above 122°F (50°C).

Important:

- Use only with ReliOn® Confirm blood glucose meter and ReliOn® Confirm/micro blood glucose test strips.

- ReliOn® Confirm/micro CONTROL is not intended for human consumption. Do not drink.
- Do not apply to eye. Contact your healthcare professional immediately if solution is swallowed, injected, or applied to the eye.
- Dye in control solution may stain skin, clothing, or surfaces.
- Store the control solution between 34-86°F (1-30°C). Keep away from direct sunlight, fluorescent light, and heat. Do not freeze.
- Use before the expiration date printed on bottle.
- Use the control solution within 3 months of first opening. It is recommended that you write the date of opening on the control solution bottle label (OPEN DATE) as a reminder to dispose of the opened solution after 3 months.
- Always replace the cap immediately after use.
- ReliOn® Confirm/micro CONTROL is not a cleaning solution. Do not clean your ReliOn® Confirm blood glucose meter with ReliOn® Confirm/micro CONTROL.
- Do not use the control solution when the solution level falls below the bottom edge of the label on the bottle.
- Use the Control Solution between 72-82°F (22-28°C).

Step 1: Insert a test strip as shown in diagram. Test strip should seat firmly into meter. The meter will turn on automatically. The full screen will come on for a moment. Make sure all symbols appear on the screen (see page 8). The last result will then appear. Then the code number (F-2, F-3, or F-4) will appear for three seconds followed by the Apply Blood symbol. Make sure that the code number on the screen matches the code number on the test strip bottle. If screen code does not match the test strip code, use a new test strip. If code still does not match, use a new bottle of test strips or call Customer Service at 800.631.0076 (24 hours a day, 7 days a week).

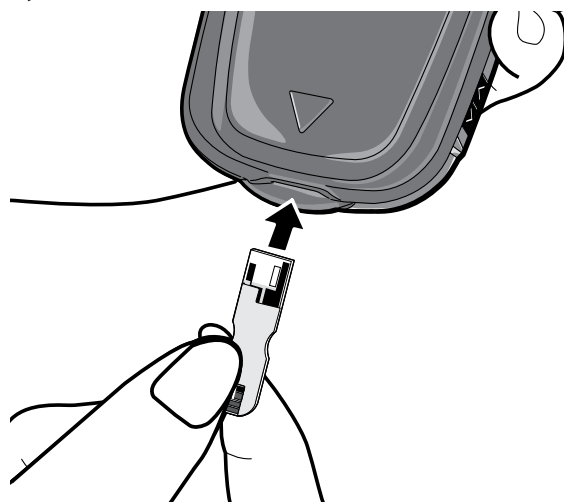

Step 2: Press the Up Arrow button to enter the control mode.

You will see "CONT" on the bottom right of the screen.

If you do not enter the control solution mode, the control solution result will NOT be valid.

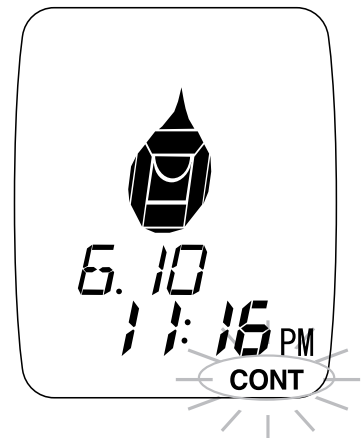
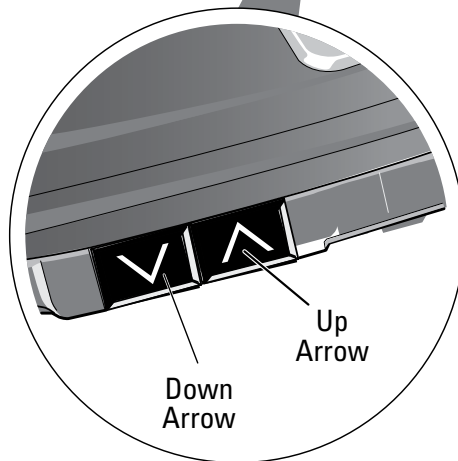
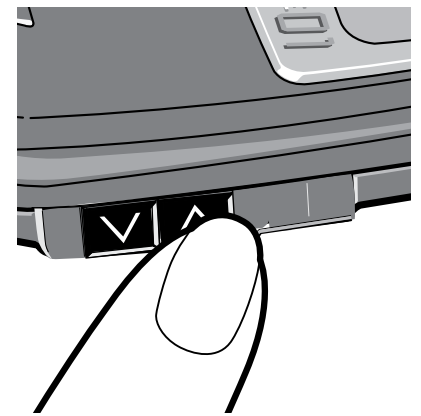

Step 3: Mix control solution by gently inverting bottle. Remove the cap from the control solution bottle. While the Apply Blood symbol  is flashing, place a drop of the control solution on the **end** of the test strip. **DO NOT put control solution on top of the test strip.** The test strip will draw up the solution and the meter will beep. The meter will begin to count down.

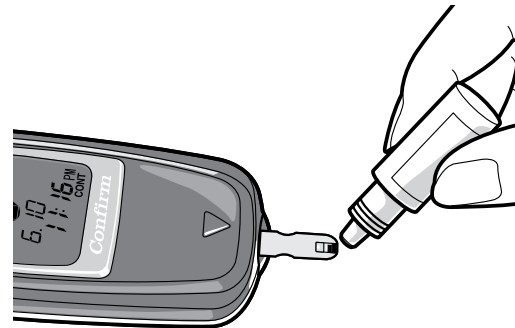

Step 4: In 7 seconds the meter will beep again and display the control solution result. **Compare the result to the range printed on the test strip bottle.** Make sure the result is within the acceptable range. If the result falls within this range, the meter and test strip are working correctly.

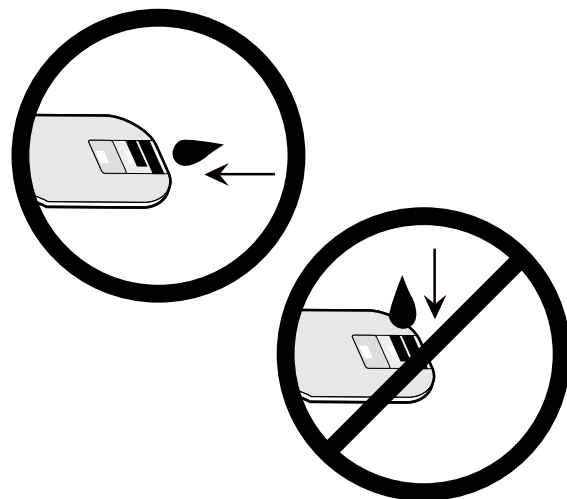

Do not use the system if control solution result is out of range. See Troubleshooting Control Solution Test (page 30).

Result is automatically stored in memory. See page 42 for additional information

Step 5: Remove test strip. Dispose of the used test strip.

Control solutions are available in three (3) levels - Low (L), Normal (N), and High (H).

Repeat Steps 1-5 with other Control Solution levels as per recommendations of your healthcare professional.

To order control solution, call ReliOn® at 800.631.0076.

NOTE: Control solution test results are not included in the averages.

Troubleshooting Control Solution Test

If the control solution test result is out-of-range, check the following and repeat the test:

Check	Action
Did you do the test in control solution mode? Do you see "CONT" on the screen with the result?	If not, do the test again. Insert a test strip; press the Up Arrow button for control solution mode. "CONT" should appear on screen.
Have the test strips and/or control solution expired?	Make sure that test strips and control solutions are not past expiration date. This date is shown on bottle. Make sure bottles have not been opened for more than three months.
Were control solutions at room temperature (72-82°F (22-28°C)) when used?	If not, retest with new bottle of control solution, or warm up/cool down to room temperature.
Does the code on the test strip bottle match the code on the meter screen?	If not, obtain a new bottle of test strips.

Check	Action
Did you insert test strip firmly into meter?	Make sure test strip is inserted all the way into test strip port. See diagram on page 26.
Did you follow the procedure correctly?	Reread "Performing a Control Solution Test" (pages 24-29) and retest.
Were test strips stored correctly (between 34-86°F (1-30°C))? Was the bottle cap replaced immediately after removing a test strip?	If not, retest with a new bottle of test strips.
Is the meter damaged? Does it show an error code?	If yes, contact Customer Service at 800.631.0076.

Does your Control Solution result still read outside the range printed on the test strip bottle? If yes, the system may not be working correctly. DO NOT USE the system to test your blood glucose until the control solution result is within range. If you need help, please call Customer Service at 800.631.0076 (24 hours a day, 7 days a week, USA). Contact your diabetes healthcare professional if you cannot reach Customer Service.

BLOOD GLUCOSE TESTING

The Lancing Device

Step 1: Pry the depth adjustment cap sideways to remove it.

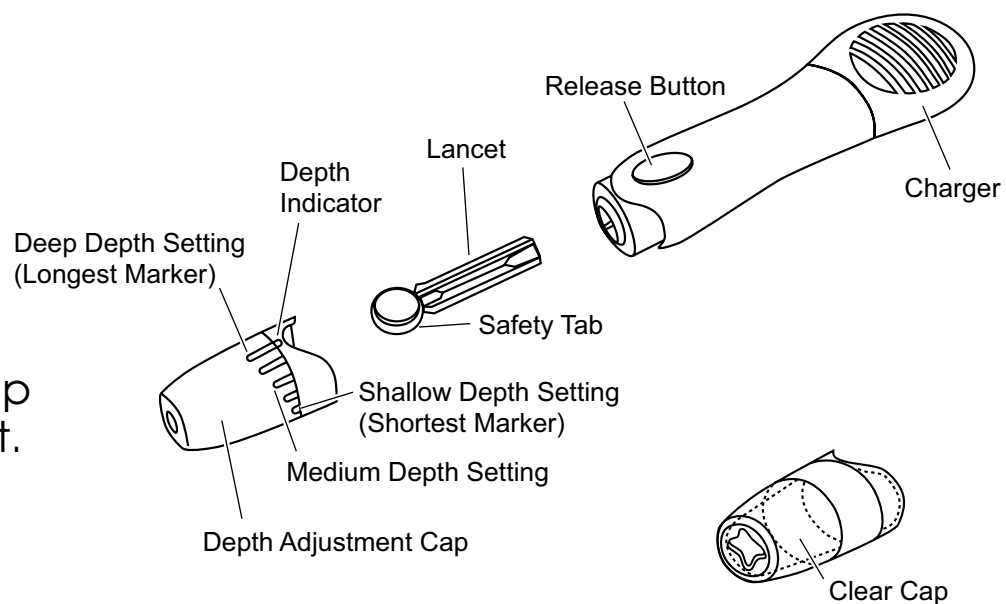
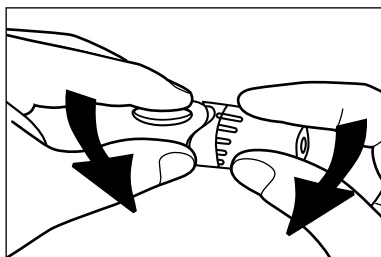

NOTE: Do not use the lancet if the cap is missing or damaged.

Step 2: Insert a new, unused lancet into the Holder until it stops.

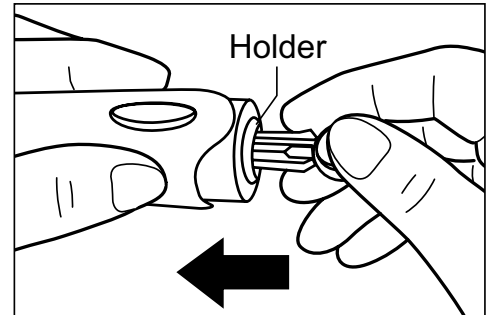

Step 3: Twist off the safety tab.

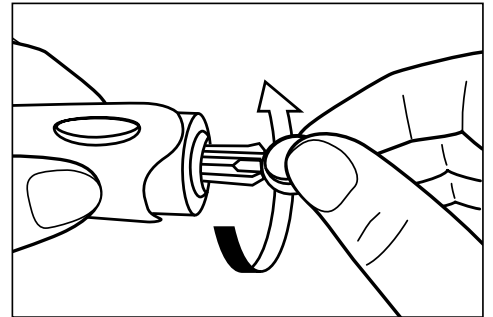

Step 4: Attach the depth adjustment cap.

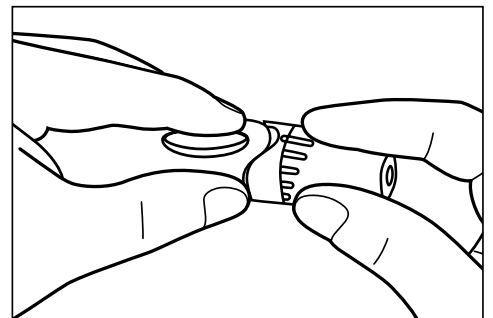

Step 5: Adjust the depth of puncture setting if necessary. If the obtained amount of blood is excessive, turn the dial to a lower setting. If the obtained amount of blood is insufficient, turn the dial to a larger setting.

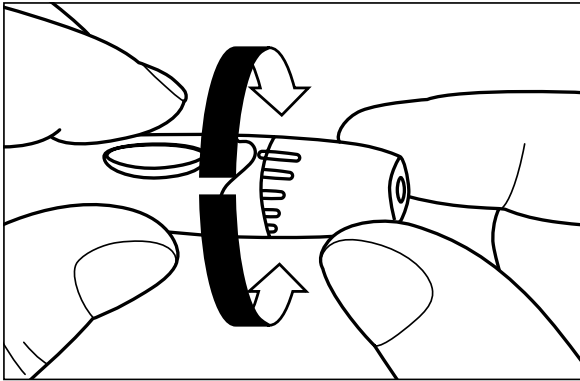

Level indications

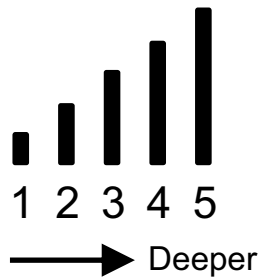

There is no numeric inscription on the Lancing Device.

Step 6: Pull the charger to reset the device. You may hear a click.

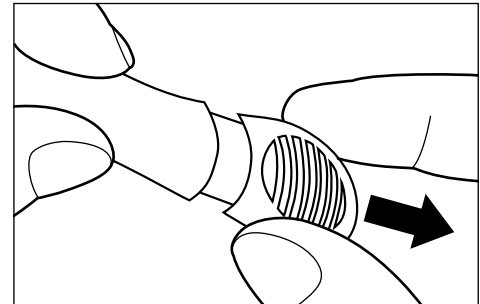

Getting a Drop of Blood

Step 1: Wash hands with soap and warm water. Dry hands thoroughly. If you use alcohol wipes to cleanse fingers, make sure the area is dry before lancing finger. Residual alcohol may lead to inaccurate readings.



Step 2: Let the arm hang down for 10 to 15 seconds. (Holding the arm below the heart and massaging the wrist, palm and finger makes it easier to obtain a blood drop).

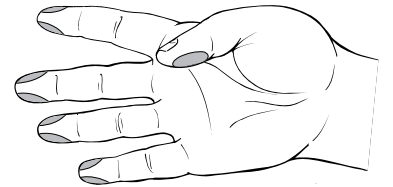

Step 3: Choose a site on the side of a fingertip to minimize pain.

Step 4: Press the depth adjustment cap to the side of the fingertip. Push the release button.

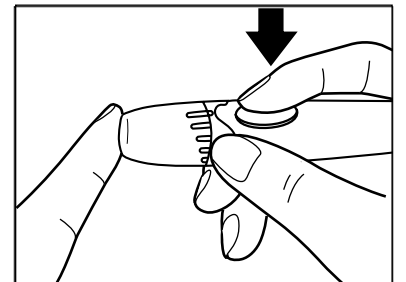

Step 5: Set aside the lancing device and wait a few seconds for a blood drop to form. Keeping the hand warm, lowering the hand to waist level and gently massaging your wrist, palm or the base of the finger helps the flow of blood. Use a different site each time you test to help prevent soreness and calluses.

NOTE: A lancet should only be used once. Dispose of used lancet in a safe manner so as not to cause accidental injury.

WARNING: DO NOT share used lancets with another person. To prevent possible infection, a used lancet should not be touched by another person.

Performing a Blood Glucose Test

NOTE: Four and a half minutes after test strip insertion, a beep sounds every 5 seconds. After 5 minutes, a beep sounds and the meter turns off. Take out unused test strip and insert it again to turn meter back on.

Step 1: Remove test strip from the bottle. Immediately replace the bottle cap tightly. **Insert test strip as shown in diagram.** A beep will sound and the meter will turn on automatically. Verify that all symbols appear on the screen.

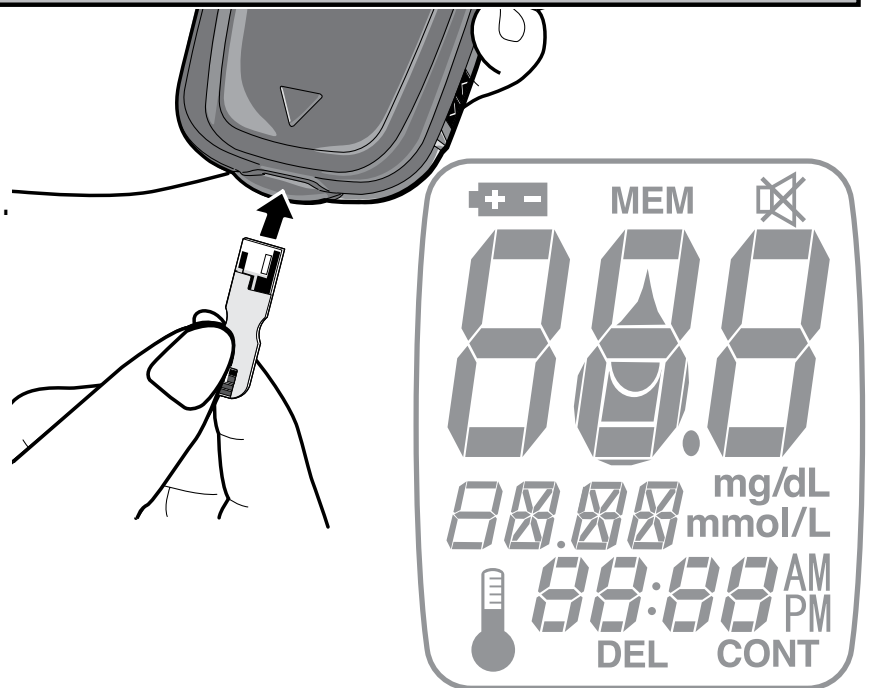

Step 2: The beep will sound again. The last result will then appear. Then the code number (F-2, F-3, or F-4) will appear for three seconds followed by the Apply Blood symbol . **Verify that the code number on the screen matches the code number printed on the bottle.** If the code number does not match, the meter may give a false reading. If code does not match, use a new strip. If code still does not match, use a new bottle of test strips or call Customer Service at 800.631.0076 (24 hours a day, 7 days a week). Verify that the date and time appear on the screen and are correct. If date and time are not correct, reset them (see Meter Set-up, page 13).

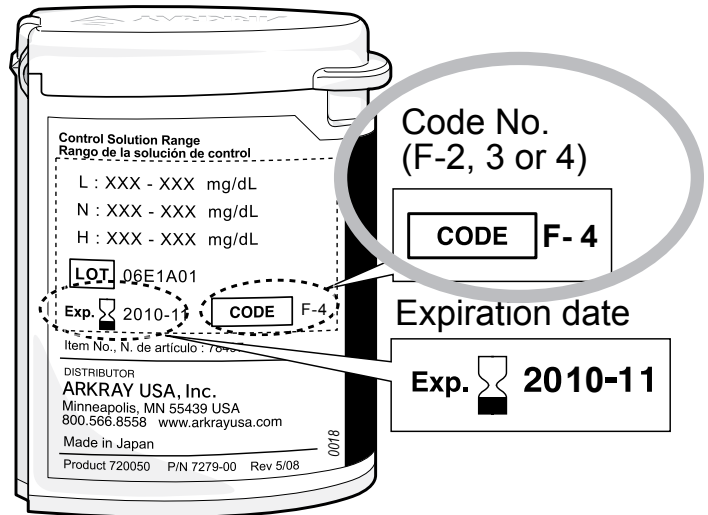
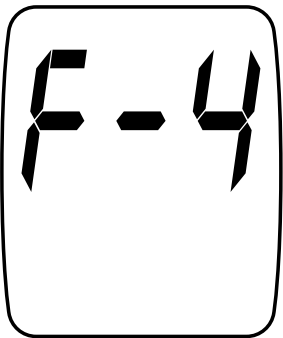

Step 3: Obtain a blood drop (see pages 36-37). **Apply blood to the end of the test strip.** Capillary action will pull the blood into the strip. The meter will beep when it detects that blood has been applied. The meter will begin to count down. Do not add blood on top of the test strip, as you may receive an inaccurate result.

Important: Ensure that enough blood is applied to fill the check window and it turns red. When the check window is filled with blood and a beep sounds, remove the tip of the test strip from your finger. If there is not enough blood, "E-7" or "Lo" will be displayed.

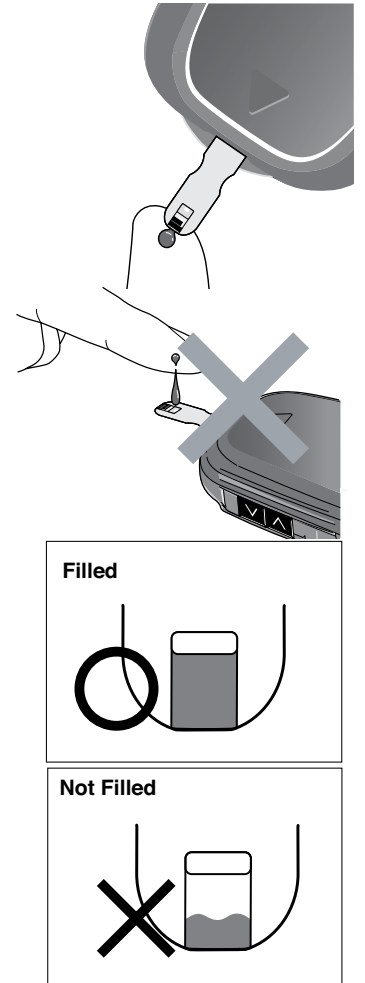

If it takes longer than 20 seconds to obtain a blood sample and to touch the test strip to the blood drop, repeat Step 3.

Step 4: The meter will count down, showing a flashing dash. After 7 seconds, a beep sounds and the test result and date/time are shown.



Results will be shown in units of mg/dL.

Record result in your logbook.

Step 5: When the test is done, pull out test strip. Dispose of used test strip. The meter shuts off automatically when you remove the test strip.

Remove lancet from lancing device. Dispose used lancet according to local guidelines.



Flagging Test Results

You can mark a test result with either “DEL” or “CONT” or leave it unmarked.

You must mark the test result after it has been displayed, but before you remove the test strip from the meter. You cannot change the marker after removing the test strip from the meter.

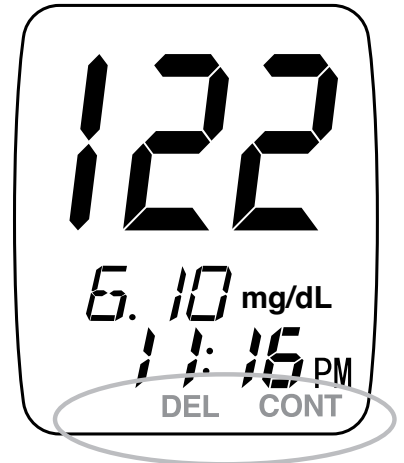

- **“DEL”**: Mark a test result with “DEL” if you feel the result is incorrect or the test procedure was not followed correctly. The result will be stored in memory, but will not be used for Test Averaging. (See page 21).
- **“CONT”**: Mark control solution test results with “CONT”. (See page 23).

Step 1: Wait for test result to be displayed. Be sure test strip is still in meter. Press the Up Arrow button to cycle through the options: “DEL” —> “CONT” —> Unmarked —> “DEL”, etc.

Step 2: When you have selected the desired marker, remove the test strip. When you recall the result from memory, the selected marker will be displayed (“DEL”, “CONT” or no marker).

NOTE: The following are NOT included in the 14-day or 30-day test averages:

- Results collected in Control Solution mode (and therefore marked “CONT”).
- Results marked “CONT” or “DEL” by you.
- Results obtained when date and time have not been set.

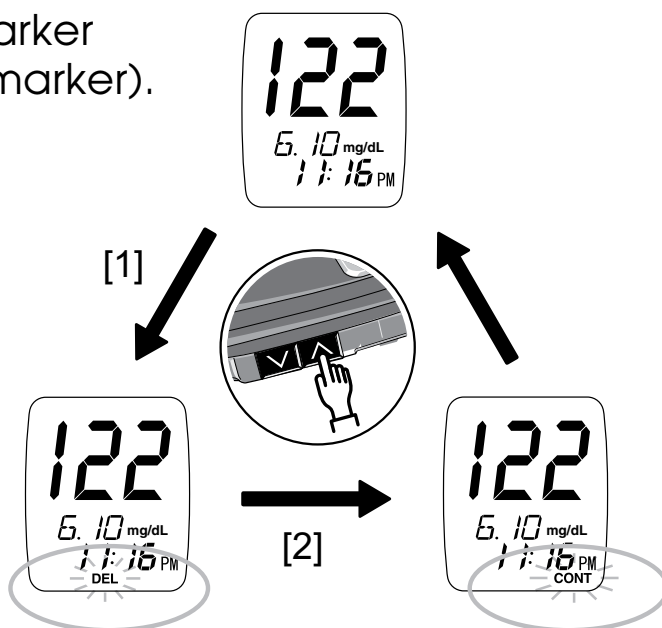

NOTE: Results collected in Control Mode automatically show “CONT” when the result is first displayed and when it is reviewed in Memory.

ALTERNATE SITE TESTING (AST)

Important Information About AST

Sites other than your fingertip may have fewer nerve endings so obtaining a blood sample from these sites may be less painful. The technique for alternate site testing is different from fingertip testing. Blood glucose testing results from sites other than your fingertip could be significantly different. Physiological differences in circulation between the fingertip and palm may result in differences in blood glucose measurements between these sites. Differences in glucose concentrations may be observed after eating, taking insulin medication, or exercise and are typically shown more quickly in the fingertip than in the palm.

Consult with your diabetes healthcare professional prior to testing from a site other than your fingertips.

Consider Alternate Site Testing When:

- Testing before a meal.
- You are in a fasting state.
- Two hours have passed since a meal.
- Two hours have passed since insulin dosing.
- Two hours have passed since physical activity.

Use Fingertip Testing:

- Within two hours after a meal.
- Within two hours after insulin dosing.
- Within two hours after physical activity.
- If you have a history of hypoglycemia, are experiencing low blood glucose, or suffer from hypoglycemic unawareness (you cannot tell when you have low blood glucose).
- To confirm your blood glucose level if your AST result is not consistent with how you feel.
- During times of stress or illness.

Ask your diabetes healthcare professional about recommended testing procedures when operating machinery or driving a car, as fingertip testing is usually the preferred method of testing under these circumstances.

If bruising occurs, you may choose to lance a fingertip instead.

Preparing to Test Your Blood Glucose From an Alternate Site

Choose a Site: Select a soft, fleshy area on the palm that is free of visible veins and moles and away from bone. Wash the area with warm, soapy water. Rinse and dry completely. If you use alcohol wipes to cleanse the site, make sure the area is dry before lancing the site.

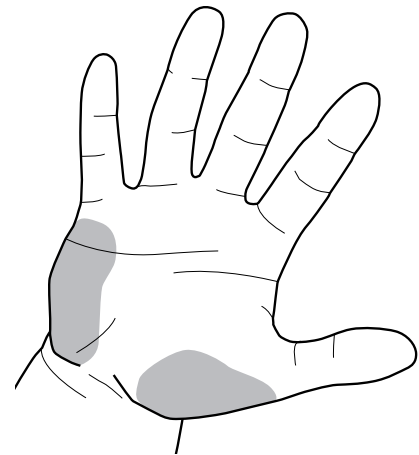

Performing a Blood Glucose Test From an Alternate Site

Step 1:

Insert lancet and cock lancing device.

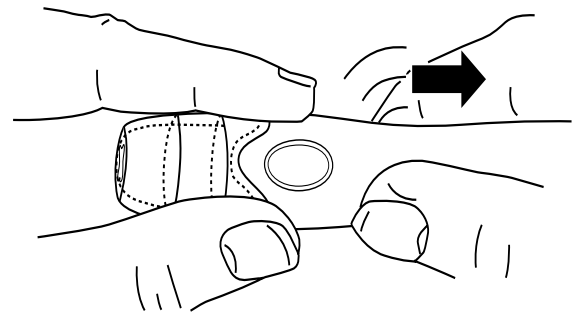

Step 2:

Remove test strip from the bottle. Immediately replace the bottle cap tightly. **Insert test strip as shown in diagram.** A beep will sound and the meter will turn on automatically. Verify that all symbols appear on the screen (see page 8). The last result will then appear.

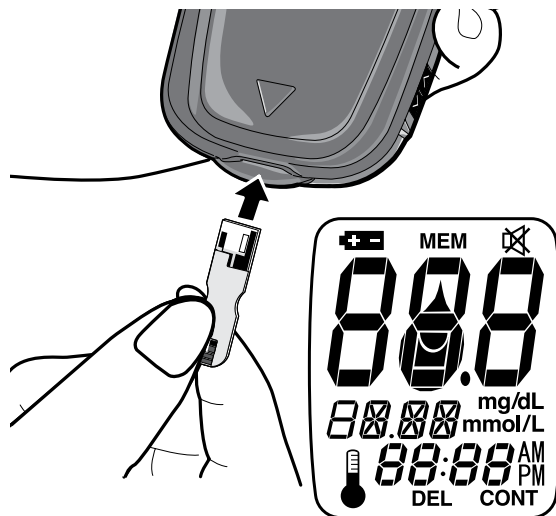

Verify that the code number displayed on the screen matches the code number on the bottle of test strips used.

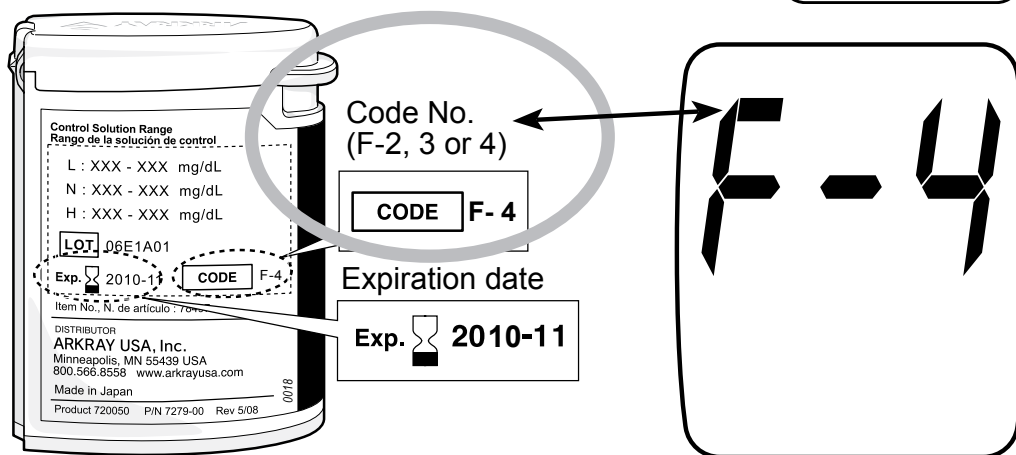

Step 3:

a) PRESS AND VIGOROUSLY RUB THE SELECTED AREA for 10 seconds until it starts to feel warm to the touch.

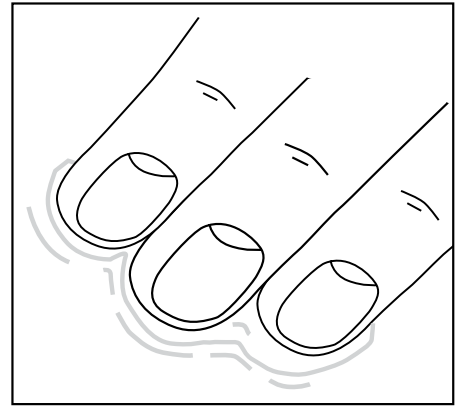

b) Firmly hold the cocked lancing device against the clean skin for 5-10 seconds.

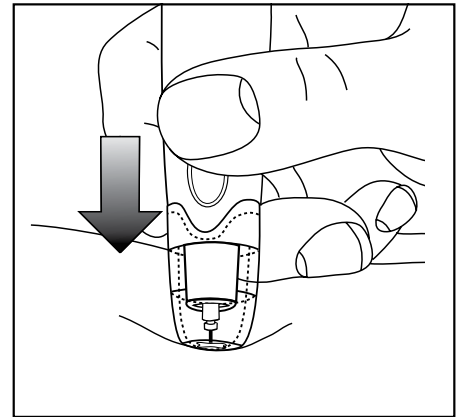

c) Press the release button on the lancing device to lance the skin. **Continue to hold the lancing device firmly against the skin** until a blood drop forms.

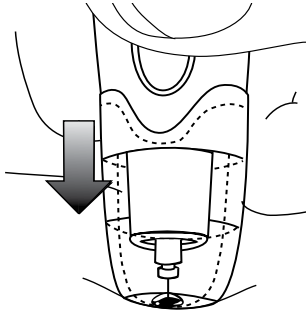

d) Once a large enough drop of blood has formed, remove the lancing device.

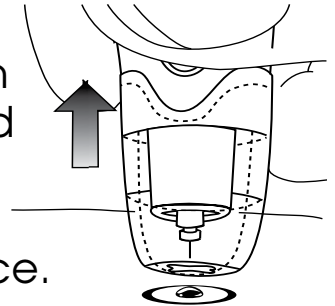

IMPORTANT

Repeat blood draw if fluid is clear.

IMPORTANT

If it takes longer than 20 SECONDS to obtain a blood sample, and any sample has been applied to the strip, discard strip and use a new strip before proceeding.

IMPORTANT!

Insert strip VERTICALLY into blood sample, NOT at an angle.

Step 4:

Pick up the meter and touch the end of the test strip to the blood sample until the reaction site is full. Immediately remove the meter and test strip from the blood drop.

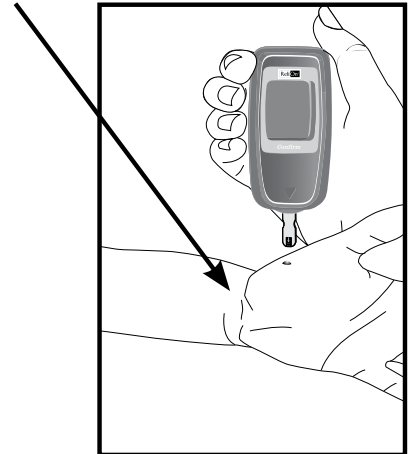

IMPORTANT

- Was the sample free of clear or watery fluid?
- Was the drop large enough (at least 0.3 μL)?
- Did the reaction site fill with enough blood all at once?

**IF NOT,
REPEAT TEST.**

Step 5:

The meter will count down, with a flashing dash, and display result in 7 seconds.

CONSIDER YOUR RESULT. REPEAT ALTERNATE SITE TEST:

- IF the blood sample appeared to be diluted with clear fluid.
- IF you did not vigorously rub the test site.
- IF the blood drop was not large enough to fill the reaction site.
- IF the test was accidentally marked as a "Control" result.
- IF your result was not consistent with how you feel.
- IF more than 20 seconds elapsed from sample collection to measurement (evaporation of the blood sample may cause a test result that is higher than the actual value).

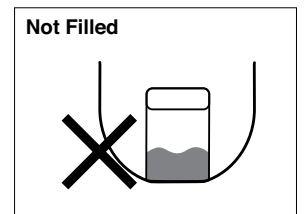
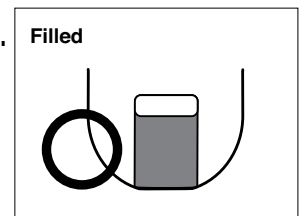

Any of the above situations can lead to an inaccurate test result. 51

If the repeated alternate site result is still not consistent with how you feel, confirm your blood glucose level with fingertip testing.

Step 6: Always **record your results in your self-testing logbook** along with other information such as insulin dosage, diet, and exercise.

The result is automatically stored in memory with the time and date.

Step 7: Remove the test strip and dispose of it in accordance with local guidelines or as directed by your healthcare professional.

The meter shuts off automatically when the test strip is removed.

Understanding Test Results

The ReliOn® confirm blood glucose meter is referenced to a fresh plasma sample. Your meter results may differ from clinical lab results. This is due to normal variation. To compare your meter with lab results, follow the guidelines below.

Before you compare

Perform a control solution test. This makes sure your meter and test strips are working correctly. Wait at least 2 hours after a meal or drink (other than water) before doing a comparison. If the lab test needs venous blood, you must fast before giving a blood sample.

When at the lab

Blood samples for both tests must be taken and tested within 15 minutes of each other. Collect blood for the lab test with an approved preservative. Heparin samples of blood may be used. See test strip insert for additional information. ReliOn® Confirm blood glucose meter is plasma referenced.

ALWAYS wash hands with warm soapy water. Rinse and dry them before testing. **ALWAYS** use fresh capillary whole blood on meter tests.

You may still see a difference from the lab result. This can be due to several causes. Blood glucose levels can change over short periods of time, for example due to food or stress. Test strip results also may vary due to medications or to low or high hematocrit.

Analyze data with a clinically acceptable method.

Your test results will vary over time. For example, results may vary due to:

- 1) The time of day the test was done.
- 2) The food you eat.
- 3) Activities you do.
- 4) The insulin and other medications you take.

If your readings do not seem correct, repeat the test. Contact your healthcare professional immediately if:

- abnormally high or low readings persist.
- your test results do not match your symptoms.

Normal Blood Glucose Readings

Expected blood glucose levels for adults without diabetes^{1,2}:

Fasting	70 to 110 mg/dL
1 to 2 hours after meals	<120 mg/dL

High Blood Glucose Readings

If your blood glucose is above 600 mg/dL, you will receive a “Hi.” Repeat the test with a new test strip. If this message shows again, contact your healthcare professional immediately!

Contact your physician for advice if test results are very high³ (above 240 mg/dL) and/or you have symptoms of high blood glucose. These symptoms include dry mouth, thirst, frequent urination, nausea, vomiting, blurred vision, sleepiness, or abdominal pain. Symptoms will vary person to person. You may have one or all of these symptoms.

Low Blood Glucose Readings

If your blood glucose is below 20 mg/dL, you will receive a “Lo.” Repeat the test with a new test strip. If this message shows again, contact your healthcare professional immediately!

Contact your physician for advice if test results are very low⁴ (below 70 mg/dL) and/or you have symptoms of low blood glucose. Symptoms of low blood glucose include sweating, shakiness, trembling, blurred vision, hunger, headache, confusion, rapid heartbeat, or tingling or numbness around the mouth or fingertips. Symptoms will vary person to person. You may have one or all of these symptoms.

Recent Diabetes Findings

In 1993, the National Institutes of Health reported a study of people with Type 1 diabetes. This study was called the Diabetes Control and Complications Trial (DCCT). It found that good blood glucose control can reduce the risk of complications by about 60%⁵. This helps protect the eyes, kidneys, and nervous system from damage due to diabetes.

What This Means For You

Frequent blood glucose testing is the best means to track how well you are doing with your diabetes management. It helps you track the effects of medications, diet, exercise, and stress management. Blood glucose test results can also tell you if your diabetes is changing. This may alert you to adjust your treatment plan. Always consult your healthcare professional before making any adjustments.

Frequency of Testing

Work with your healthcare professional to decide when and how often to test. This will depend on such things as age, type of diabetes, and medications. It is important to make testing part of your daily routine.

References

- 1 Burtis, C.A. Ashwood, E.R., eds.: Tietz Textbook of Clinical Chemistry. 2nd Edition. Philadelphia: W.B. Saunders. (1994), 2190.
- 2 Krall, L.P. and Beaser R.S.: Joslin Diabetes Manual. Philadelphia: Lea and Fibiger (1989), 138.
- 3 Krall, L.P. and Beaser R.S.: Joslin Diabetes Manual. Philadelphia: Lea and Fibiger (1989), 261–263.
- 4 Kahn, R. and Weir, G.: Joslin's Diabetes Mellitus. Philadelphia: Lea and Fibiger (1994), 489.
- 5 American Diabetes Association position statement on the Diabetes Control and Complications Trial (1993).

RECALLING RESULTS - ENTERING MEMORY MODE

The ReliOn® Confirm blood glucose meter stores up to 360 test results. When more than 360 test results have been performed, the meter drops the oldest result each time you add a new result. Before using the memory, remove test strip from meter and make sure meter is turned off.

Step 1: Press the Up Arrow button for 2 seconds.

A beep sounds and the test meter turns on and shows all screen symbols. The meter next shows the year, date, and time. After 2 seconds, either the Test Average or the most recent test result will appear.

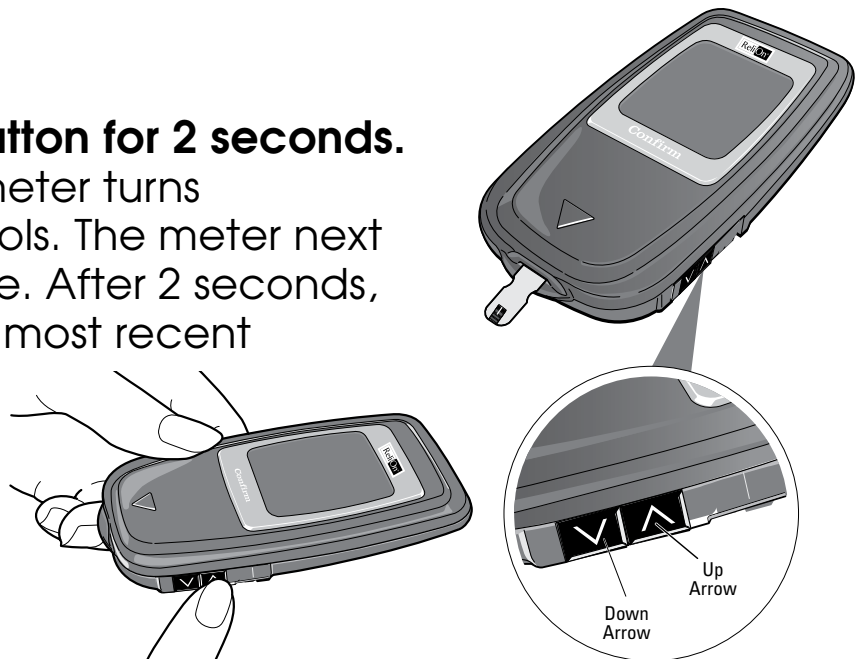

- If Test Averaging has been turned on, the average result will appear first. Either "14d" or "30d" will show at the bottom of the screen for either a 14-day or 30-day average. "AVE" will appear above "14d" or "30d".
- If Test Averaging has been set to "Off", the display will briefly flash the number "1" at the bottom of the screen. Then, the most recent test result appears with the date and time of the test.

"MEM" will display at the top of the screen. This shows it is a stored result.

Step 2: Press the Up Arrow button to scroll through memory. Press and hold the Up Arrow button to move through the results quickly. Press the Down Arrow button to move backwards through results in memory.

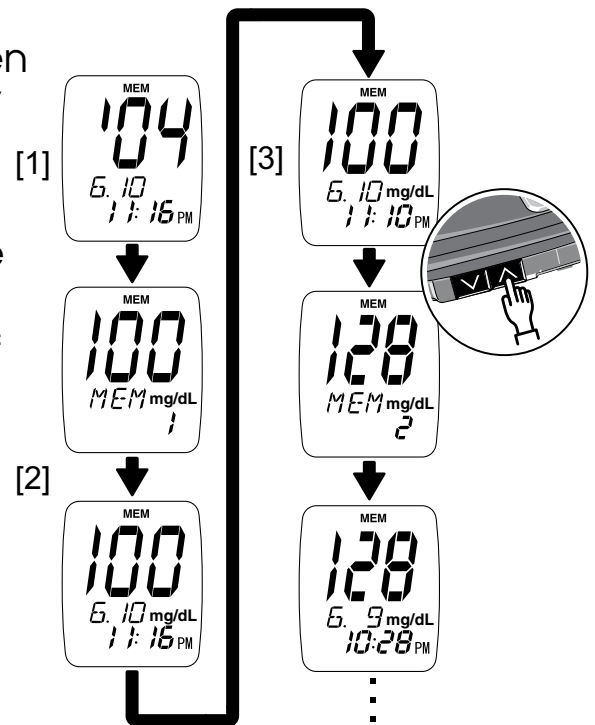

Step 3: After all test results have been reviewed, "End" appears.

- Press the Up Arrow button once to go back to the first result in memory. You can then scroll through results in memory again.
- Press the Down Arrow button for 2 seconds to exit Memory and turn off the meter. You can exit Memory in this way at any time when recalling results.

Note:

- If no tests have been performed, or all test results have been deleted, the current date and time appear first, then "End" appears.
- If 3 minutes elapse before either the upper or lower button is pressed, a beep sounds and the test meter turns off automatically.

Deleting all test results

Step 1: Press both the Up Arrow and Down Arrow buttons for 5 seconds while "End" is shown. You will see "dEL" and "ALL" alternating on the screen.

Step 2: Next press the Down Arrow button for 5 seconds. "End" appears again. All test results have now been deleted.

Step 3: Press the Down Arrow button for 2 seconds to turn off test meter.

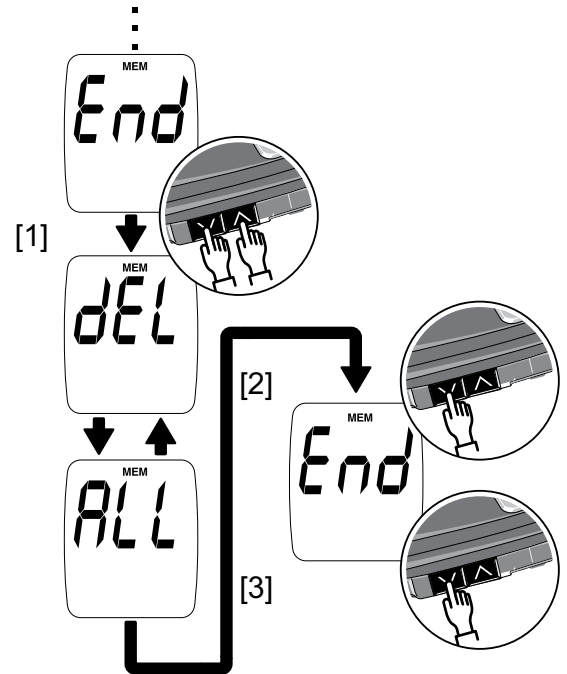

Note: To get to "End" of memory results quickly, turn off meter, then enter Memory Mode. Next press the Down Arrow button to go backwards in the memory list to reach "End".

Note: Deleted test results cannot be recovered.

MAINTENANCE

Cleaning

To prevent malfunction of the meter, keep the test strip port free of blood, moisture, dirt, or dust. Use a lint-free cloth dampened with water to clean meter. Thoroughly wring out cloth before use. Do not use an abrasive cloth or antiseptic solution, as these may damage the display screen. Do not clean inside battery compartment.

Storage and Handling

- Store meter at 32°F-122°F (0°C-50°C).
- Do not leave the meter in very hot or cold places. Do not leave it near a heat source (radiator) or in a car in hot or cold weather.
- Do not store or use meter or test strips:
 - in high humidity, such as a bathroom or kitchen.
 - near a strong electromagnetic field such as a microwave oven or cell phone.
- Do not use a meter that has been dropped into water, or if any water has entered the meter. Even if you dry it, correct test results may not be obtained, and malfunction may result.
- Do not store meter or test strips near bleach or cleaners that contain bleach.
- Do not drop meter. This can damage the meter. If you do drop meter, check it with a control solution test.
- Do not take the meter apart.
- Do not leave test strips out of their bottles.
- Do not hold test strips with fingers for a long period of time.
- Do not hold test strips with wet or dirty fingers. Otherwise correct test results may not be obtained.

If you have technical problems or questions, please call Customer Service at 800.631/0076 (24 hours a day, 7 days a week). Contact your healthcare professional with questions if you cannot reach Customer Service.

Display Screen and Error Messages

Please first read this section. If you still have questions, call Customer Service at 800.631.0076 (24 hours a day, 7 days a week). Contact your healthcare professional if you cannot reach Customer Service. Do not send your meter to ARKRAY or your local dealer without first calling to get approval to do so.

If any part of the display screen is missing when the meter is turned on, call Customer Service at 800.631.0076.

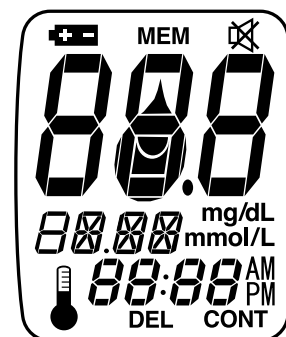

Your blood glucose level is less than 20 mg/dL or there was not enough blood on test strip. Repeat test with new test strip. Make sure you use enough blood to fill the strip. If this message shows again, contact your healthcare professional immediately!



Your blood glucose level is more than 600 mg/dL. Repeat test with new test strip. If this message shows again, contact your healthcare professional immediately.



Battery power is too low for testing. Replace batteries immediately. Results may not be accurate when testing with low battery symbol on.

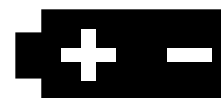

Thermometer symbol. The meter temperature is outside acceptable range of 50°F-104°F (10°C-40°C). Allow the meter and test strips to warm up or cool down slowly (20 minutes) until the temperature warning symbol goes away.



The meter is faulty. Contact Customer Service at 800.631.0076.

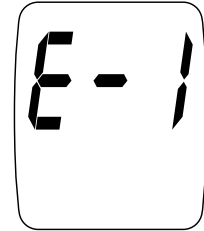

The meter temperature is outside acceptable range of 50°F-104°F (10°C-40°C). Allow the meter and test strips to warm up or cool down slowly (20 minutes) until the temperature warning symbol goes away.

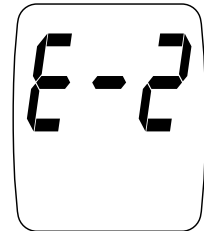

The meter is faulty. Contact Customer Service at 800.631.0076.

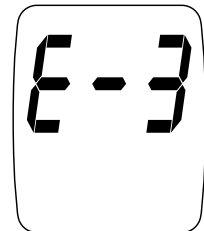

The meter is faulty. Contact Customer Service at 800.631.0076.

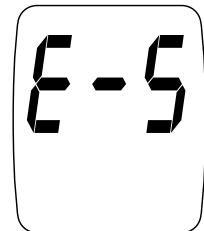

Test strip problem. Contact bars on test strip may be dirty. Incorrect test strip used. Used test strip has been inserted. Repeat test with new test strip.

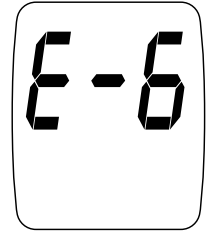

Not enough blood added to test strip. Or incorrect blood application technique. Retest with new test strip.

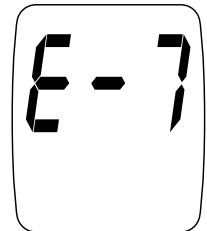

Code Number. This shows the code number currently in the meter. The number on the screen must match the number on the test strip bottle. If screen code does not match the test strip code, use a new test strip. If code still does not match, use a new bottle of test strips or call Customer Service at 800.631.0076.

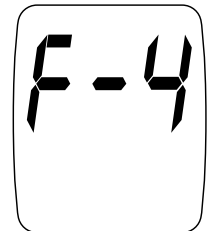

Apply Blood Sample. The Apply Blood symbol flashes showing that the meter is ready for the blood sample.



Apply Control Solution. The Apply Blood symbol flashes and "CONT" appears at the bottom of the screen. This shows the meter is ready for you to apply control solution.

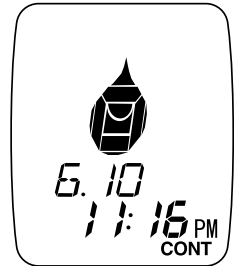

Test Result. The meter shows results between 20 and 600 mg/dL.

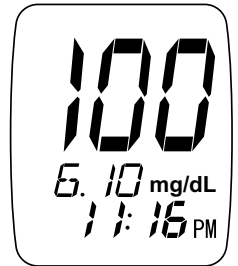

Test Average has no results stored. Test Averaging has been set to 14-day or 30-day but there are no results stored yet in memory.

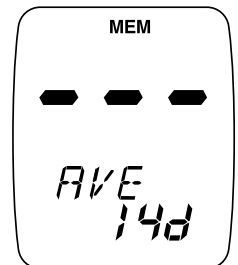

For errors not listed, do not attempt to use meter. Contact Customer Service at 800.631.0076.

PRODUCT INFORMATION

Product Specifications

Test Strips:	ReliOn® Confirm/micro test strips.
Result Range:	20-600 mg/dL .
Calibration:	Plasma referenced.
Sample Size:	Minimum 0.3 µL.
Blood Source:	Fresh capillary whole blood.
Hematocrit Range:	30% - 54%.
Test Time:	7 seconds.
Assay Method:	Biosensor, Glucose Oxidase (<i>Aspergillus niger</i> sourced).
Power Source:	One 3-volt lithium battery (CR2032 or DL2032)
Battery Life:	Approximately 2,000 tests
Screen Type:	Liquid Crystal Display (LCD).
Memory:	360 results with time & date stamp.
Average:	14-day or 30-day averaging.
Automatic Shut Off:	3 – 5 minutes after last user action.
Size:	2" x 3.9" x 0.5".
Weight:	1.6 oz (with battery).
Operating Ranges:	50°F-104°F (10°C-40°C), 20% - 80% relative humidity.
Altitude:	10,000 ft. (3,048 meters).
Unit of Measurement:	mg/dL.

Warnings, Precautions & Limitations

- You may get test results higher than your actual glucose level if taking PAM (1-Methylpyridine-6-carbaldehyde oxime). Taking unnecessary measures to lower your blood glucose level may induce severe low blood glucose symptoms such as coma.
- Never make significant changes to your diabetes control program or ignore physical symptoms without consulting with your healthcare professional.
- Patients undergoing oxygen therapy may yield false results.
- Heparin samples of blood may be used. Do not use other preservatives.
- Do not grasp the meter near the test strip port. A built-in thermosensor used to minimize measurement errors is installed just inside the port. If you hold this area, it will be warmed by your fingers, which will adversely affect test results.
- Severe dehydration (excessive water loss) may cause false low results. If you believe you are suffering from dehydration, consult your healthcare professional right away.

- Extremes in hematocrit may affect test results. Hematocrit levels less than 30% may cause falsely high readings. Hematocrit levels greater than 54% may cause falsely low readings.
- Inaccurate results may occur in severely hypotensive individuals or patients in shock. Inaccurate low results may occur for individuals experiencing a hyperglycemic-hyperosmolar state, with or without ketosis. Critically ill patients should not be tested with blood glucose meters.
- Triglycerides up to 3,000 mg/dL do not significantly affect test results. However, glucose values in specimens beyond this triglycerides level should be interpreted with caution.
- Normal endogenous (within body) natural levels of uric acid, ascorbate (vitamin C), bilirubin, triglycerides, and hemoglobin do not interfere with your blood glucose results obtained.
- Externally taken drugs L-dopa, dopamine, methyl-dopa, acetaminophen, and ibuprofen will not interfere with ReliOn® Confirm blood glucose results when taken at therapeutic concentrations.

- The ReliOn® Confirm Blood Glucose Monitoring System is not designed to be a substitute for pathology laboratory equipment and should not be used for the diagnosis of diabetes.
- Use only fresh capillary blood. Do not use serum or plasma or venous whole blood.
- Do not use the ReliOn® Confirm Blood Glucose Monitoring System to test neonates. It has not been validated for neonatal use.
- Always insert the test strip into the meter first, then prick the finger. Not doing so may result in an “E-6” appearing on the display or a test result that is higher than the actual value.
- Do not use at altitudes higher than 10,000 ft (3,048 m).

Warranty

You are a valued ReliOn® customer. It is important to us that you are completely satisfied with your ReliOn® Confirm blood glucose meter.

ReliOn® warrants your ReliOn® Confirm blood glucose meter will be free from defects in materials and workmanship for a period of five years from the date of the original purchase. If during this time the meter does not work properly because of a defect in materials or workmanship, ARKRAY agrees to replace or repair, free of charge any and all parts proven to be defective and subject to warranty.

This warranty is in lieu of all other warranties, expressed or implied, including any implied warranty of merchantability or fitness for any purpose, other than stated herein.

This warranty does not apply to the performance of the ReliOn® Confirm blood glucose meter that has been damaged by accident or has been altered, misused, tampered with, or abused in any way. This warranty only applies to the original purchaser of the meter and/or its agents.

Returns

You must contact ReliOn® Customer Service at 800.631.0076 before returning your meter. You will be instructed how to return the meter to ARKRAY. Returned meters without this authorization will not be accepted.

ARKRAY USA, Inc.

Minneapolis, MN 55439 USA

TEL 800.566.8558

FAX 952.646.3110

www.arkrayusa.com

©2008 ARKRAY, Inc.

P/N 1857-00
Rev 7/09